

NG 6, 10

Proportional-Stromregelventile

Proportional flow control valves

Régulateurs de débit proportionnels

5

NG 6



①

①.1



NG 10



②



③



▶ ① **ohne** Lageregelung
Version: Standard 2,5 A

①.1 Handnotverstellung als Option

▶▶ ② **mit** Lageregelung
Version: LVDT – AC

▶▶▶ ③ **mit** Lageregelung und eingebauter Elektronik – OBE

▶▶▶ ① **without** position control
Version: Standard 2.5 A

①.1 Manual emergency override as option

▶▶▶ ② **with** position control
Version: LVDT – AC

▶▶▶▶ ③ **with** position control and on-board electronics – OBE

▶▶▶▶ ① **sans** régulation de position
Version: Standard 2,5 A

①.1 Commande manuelle de secours en option

▶▶▶▶ ② **avec** régulation de position
Version: LVDT – AC

▶▶▶▶▶ ③ **avec** régulation de position et amplificateur intégré – OBE













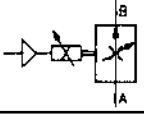

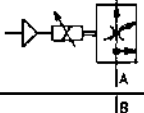
Bauart: Schieberventil
inkl. Druckwaage

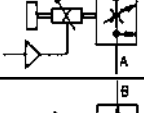
Construction: Spool type valve
incl. pressure compensator

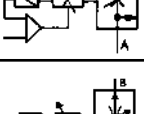
Construction: Distributeur à tiroir avec
balance de pression incorporée

NG 6, 10

Bestellübersicht Ordering code Gamme de commande

Sinnbild Symbol Symbole	NG	 A/VA max	Δp [bar]	Q: A → B [l/min] Q _A Q _B	p _{max.} [bar]		Seite Page Page	Ⓢ	
①  NO	6	2,5/30	4	- 7,5	250		128	0 811 403 118	
	10		4	- 15			0 811 403 123		
			8	- 35			0 811 403 119		
			8	- 80			138	0 811 403 013	
①  NC	6	2,5/30	4	30 7,5	250		128	0 811 403 112	
	10		8	40 35			0 811 403 113		
			8	65 60			138	0 811 403 010	
			8	30 7,5			128	0 811 403 115	
①③  NC	6	2,5/30	8	40 35	250		128	0 811 403 116	
	10		8	65 60			138	0 811 403 011	
			8	50 10			100	128	0 811 403 121 *
			8	50 35			250	138	0 811 403 117
②  NC	6	2,7/40	8	50 35	250		128	0 811 403 114	
	10		8	100 70			138	0 811 403 012	
			8	50 10			100	128	0 811 403 150
			8	50 35			250	138	0 811 403 151
③  OBE	6	24 V= 40 VA max	8	50 10	250		128	0 811 403 150	
	10		8	50 35			138	0 811 403 151	
③  NC	10	24 V= 40 VA max	8	100 70	250		138	0 811 403 019	

▶ NO – Bypass-Regelung =
2-Wege-Funktion

NC – Zulauf-Regelung =
3-Wege-Funktion

* Nur als 2-Wege-Funktion verwend-
bar, damit Q_A bis 10 cm³ regelbar ist.

▶▶ NO – Bypass control =
2-way function

NC – Supply control =
3-way function

* May only be used as a 2-way valve,
in order that Q_A can be controlled at
up to 10 cm³.

▶▶▶ NO – régulation by-pass =
fonction 2 voies





NC – régulation alimentation =
fonction 3 voies

* A utiliser uniquement en tant que
régulateurs à 2 voies afin de pouvoir
réguler Q_A jusqu'à 10 cm³.

▶ Verstärkertechnik

▶▶ Amplifier type

▶▶▶ Type d'amplificateurs

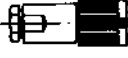
Sinnbild Symbol Symbole	mit Rampe ● with ramp avec rampe	Alphanumerik Alpha numeric Code alphanumérique		Seite Page Page	Ⓢ
P 	●	AS 2.5 – V	1-P	246	0 811 405 143
	●	AS 2.5 – mA	2-P		0 811 405 145
M 	●	1 M 2.5 – RGC1	1-M	253	0 811 405 127
K 	●	1 M 45 – 2.5 A	1-K	266	0 811 405 079
	●	QV 45	2-K		0 811 405 098
	●	QV 45 – RGC1	3-K		0 811 405 103
	●	QV 45 – RGC3	4-K		B 830 303 389
	Stecker 7-polig für OBE Plug 7-pole for OBE Connecteur 7 pôles pour OBE			241	

NG 6





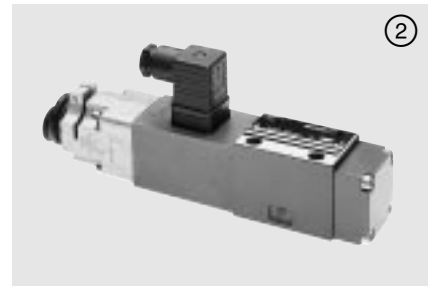

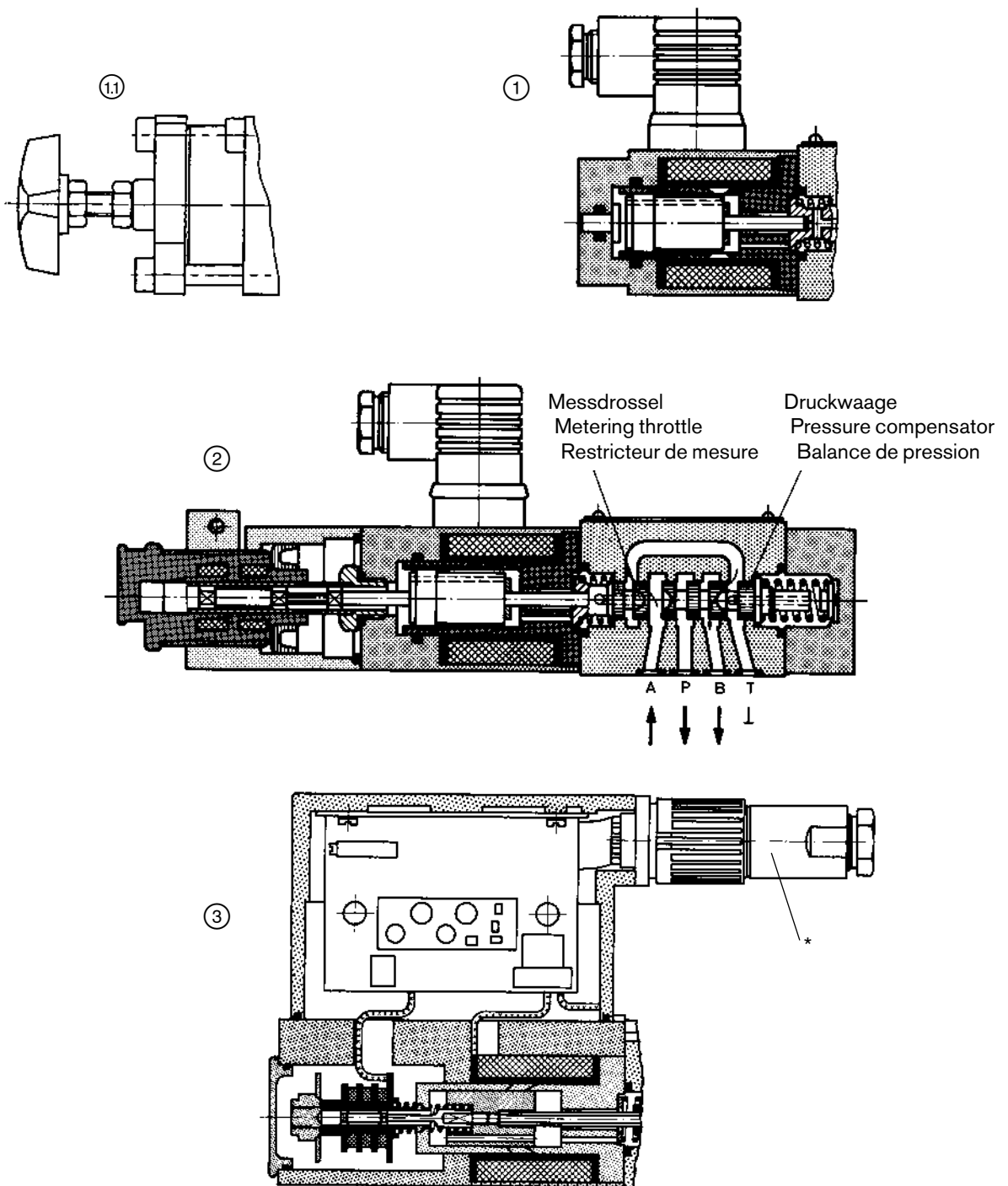

Stromregelventile Flow control valves Régulateurs de débit

Funktion
Function
Fonction

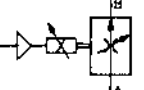
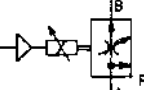
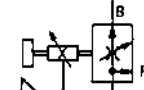
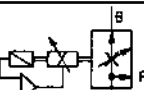
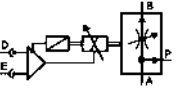
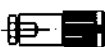

Weitere Fotos siehe Seite 126
Further photos see page 126
Autres photos voir page 126

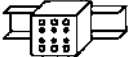

Sinnbild Symbol Symbole	 A/VA max	Δp [bar]	Q: A → B [l/min] Q _A Q _B		p _{max.} [bar]		[kg]	⊕
①  NO	2,5/30	4	-	7,5	250	1-P	2	0 811 403 118
		4	-	15		2-P		0 811 403 123
		8	-	35		1-M 1-K		0 811 403 119
①  NC	2,5/30	4	30	7,5	250	2	0 811 403 112	
		8	40	35			0 811 403 113	
①  NC	2,5/30	4	30	7,5	250	2,2	0 811 403 115	
		8	40	35			0 811 403 116	
②  NC	2,7/40	4	-	2,6	100	2-K	2,2	0 811 403 121 *
		8	50	10	250	3-K		0 811 403 117
		8	50	35	4-K	0 811 403 114		
③  OBE	24 V= 40 VA max U _{D-E} = 0 ... +10 V	8	50	10	250		3,1	0 811 403 150
		8	50	35				0 811 403 151
(4 x)  M 5 x 30 DIN 912-10.9								2 910 151 166
P 	246		AS 2.5 - V		250	1-P	0,15	0 811 405 143
			AS 2.5 - mA			2-P		0 811 405 145
M 	253	Seite Page	1 M 2.5 - RGC1		250	1-M	0,25	0 811 405 127
K 	266		1 M 45 - 2.5 A			250	1-K	0,2
		QV 45		2-K	0,2		0 811 405 098	
		QV 45 - RGC1		3-K	0,2		0 811 405 103	
		QV 45 - RGC3		4-K	0,3		B 830 303 389	
* 	Stecker 7-polig Plug 7-pole Connecteur 7 pôles Seite Page 241			250	KS		1 834 482 022	
					KS		1 834 482 026	
					MS		1 834 482 023	
					MS		1 834 482 024	
				250	KS 90°		1 834 484 252	

▶ NO - Bypass-Regelung =
2-Wege-Funktion

NC - Zulauf-Regelung =
3-Wege-Funktion

* Nur als 2-Wege-Funktion verwend-
bar, damit Q_A bis 10 cm³ regelbar ist.

▶▶ NO - Bypass control =
2-way function

NC - Supply control =
3-way function

* May only be used as a 2-way valve,
in order that Q_A can be controlled at
up to 10 cm³.

▶▶▶ NO - régulation by-pass =
fonction 2 voies

NC - régulation alimentation =
fonction 3 voies

* A utiliser uniquement en tant que
régulateurs à 2 voies afin de pouvoir
réguler Q_A jusqu'à 10 cm³.

Allgemein

Stromregelventile NG 6 sind direkt betätigte Drosselventile mit eingebauter Druckwaage.

Durchflussrichtung

Proportional-Stromregelventile mit Grundstellung geschlossen können wahlweise als 2-Wege- oder als 3-Wege-Stromregelventile verwendet werden.

Stromregelventile mit Grundstellung offen können nur als 2-Wege-Stromregelventile verwendet werden.

General

Flow control valves NG 6 are directly operated throttle valves with integrated pressure compensator.

Flow direction

Proportional flow control valves with closed basic position may be used either as 2-way or 3-way flow control valves.

Flow control valves with open basic position may only be used as 2-way flow control valves.

Généralités

Les régulateurs de débit NG 6 sont des limiteurs de débit à commande directe avec balance de pression incorporée.

Sens de passage

Les régulateurs de débit proportionnels fermés en position de repos peuvent être utilisés au choix en tant que régulateurs de débit à 2 ou 3 voies.

Les régulateurs de débit restant ouverts en position de repos ne peuvent être utilisés qu'en tant que régulateurs de débit à 2 voies.

2-Wege-Stromregelung
2-way flow control
Régulateur de débit à 2 voies

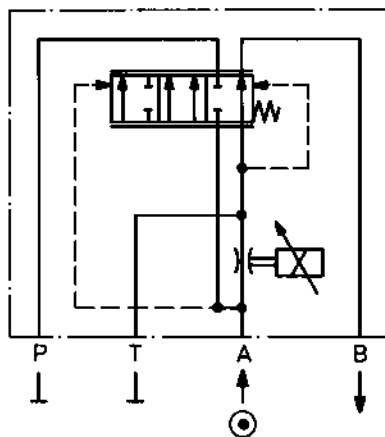
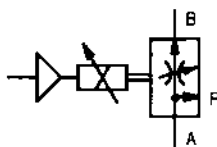

3-Wege-Stromregelung
3-way flow control
Régulateur de débit à 3 voies

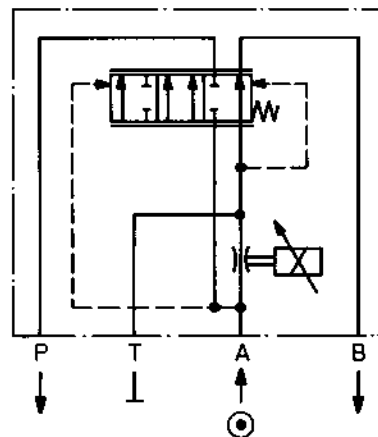
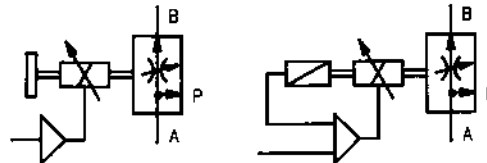

2-Wege-Stromregelventil

A: Zulauf
B: Ablauf
P: } verschlossen
T: }

3-Wege-Stromregelventil

A: Zulauf
B: Ablauf
P: Reststrom, belastbar bis 250 bar, oder Tank
T: verschlossen

2-way flow control valve

A: Supply
B: Discharge
P: } closed
T: }

3-way flow control valve

A: Supply
B: Discharge
P: Residual flow, can withstand up to 250 bar, or reservoir
T: closed

Régulateur de débit à 2 voies

A: Alimentation
B: Evacuation
P: } obturés
T: }

Régulateur de débit à 3 voies

A: Alimentation
B: Evacuation
P: Pression résiduelle, charge admissible jusqu'à 250 bar, ou réservoir
T: obturé

Kenngrößen

Allgemein

Bauart	Schieberventil mit integrierter Druckwaage
Betätigung, Proportionalmagnet	ohne Lageregelung, Option Handnotverstellung mit Lageregelung, Varianten mit/ohne eingebauter Elektronik OBE
Anschlussart	Plattenanschluss, Lochbild NG 6 (ISO 4401)
Einbaulage	beliebig
Umgebungstemperatur	-20 ... +50 °C
Rüttelfestigkeit	max. 25 g, Raumschüttelprüfung in allen Richtungen (24 h)
Prüfbedingung Version OBE	

Hydraulisch

Druckmittel	Hydrauliköl nach DIN 51 524 ... 535, andere Medien nach Rückfrage					
Viskosität, empfohlen max. zulässig	20 ... 100 mm ² /s					
	10 ... 800 mm ² /s					
Druckmitteltemperatur	-20 ... +80 °C (-20 ... +70 °C – OBE)					
Filterung	Zulässige Verschmutzungsstufe des Druckmittels nach NAS 1638					Zu erreichen mit Filter
	8					$\beta_x = 75$
	9					X = 10
	10					20
Entsprechend Betriebssicherheit und Lebensdauer	10					25
Durchflussrichtung	siehe Sinnbild					
Nenndurchfluss [l/min]	Q_B geregelt	2,6	7,5	10	15	35
	Q_A Zulauf	–	30	50	–	40 ① / 50 ② ③
$Q_{min.}$ geregelt [cm ³ /min]*	10	–	40	45	50	
Max. Betriebsdruck	Anschluss A, B: 250 bar (bzw. 100 bar) Anschluss T: verschlossen Anschluss P: verschlossen oder Reststrom 250 bar					
Mindestdruckgefälle A → B	$Q_{nom.} = 2,6$ und $7,5$ l/min: 4 ... 6 bar $Q_{nom.} = 10$ und 35 l/min: 10 ... 14 bar					

Elektrisch

Relative Einschaltdauer	100% ED		
Schutzart	IP 65 nach DIN 40 050 und IEC 14 434/5		
Anschluss Magnet	Gerätesteckdose DIN 43 650/ISO 4400		
Anschluss Wegaufnehmer	Spezialsteckdose		
Magnetstrom	ohne Lageregelung	mit Lageregelung	mit eingebauter Elektronik OBE
	max. 2,5 A	max. 2,7 A	40 VA max/24 V= nom.
	3 Ω	2,7 Ω	$U_{D,E} = 0 ... +10 V$ siehe Seite 216
Max. Leistungsaufnahme bei 100% Last und Betriebstemperatur	30 VA max	40 VA max	

Statisch/Dynamisch

Hysterese	≤ 5%	≤ 1%	≤ 1%
Umkehrspanne	≤ 3%	≤ 0,5%	≤ 0,5%
Exemplarstreuung für $Q_{max.}$	≈ 20%	≈ 5%	≈ 5%
Stellzeit 100%/10% Signalsprung	70/- ms	35/25 ms	25/25 ms
Ausregelzeit bei max. Laständerung (Druckwaage)	≤ 30 ms	≤ 30 ms	≤ 30 ms

* gilt nur für lagegeregelte Ventile

Alle Kenngrößen in Verbindung mit Proportionalverstärkern

Ventil mit Lageregelung: QV 45

Ventil ohne Lageregelung: 1 M 45 – 2.5 A

Ventil mit eingebauter Elektronik OBE: Konformität EN 50 081-1/EN 50 082-2



Characteristics

General

Construction	Spool type valve with integrated pressure compensator
Actuation, proportional solenoid	without position control, optional manual emergency override with position control, variants with/without on-board electronics OBE
Connection type	Subplate, mounting hole configuration NG 6 (ISO 4401)
Mounting position	optional
Ambient temperature range	-20 ... +50 °C
Vibration	max. 25 g, shaken in 3 dimensions (24 h)
Test condition version OBE	

Hydraulic

Pressure medium	Hydraulic oil as per DIN 51 524 ... 535, other fluids after prior consultation					
Viscosity, recommended	20 ... 100 mm ² /s					
max. permitted	10 ... 800 mm ² /s					
Pressure medium temperature	-20 ... +80 °C (-20 ... +70 °C - OBE)					
Filtration	Permissible contamination class of pressure medium as per NAS 1638			Achieved using filter		
In line with operational reliability and service life	8			β _x = 75		
	9			X = 10		
	9			20		
	10			25		
Flow direction	cf. symbol					
Nominal flow [l/min]	Q _B controlled	2.6	7.5	10	15	35
	Q _A supply	-	30	50	-	40 ① / 50 ② ③
Q _{min.} controlled [cm ³ /min]*	10	-	40	45	50	
Max. working pressure	Port A, B: 250 bar (or 100 bar) Port T: closed Port P: closed or 250 bar residual flow					
Min. pressure drop A → B	Q _{nom.} = 2.6 and 7.5 l/min: 4 ... 6 bar Q _{nom.} = 10 and 35 l/min: 10 ... 14 bar					

Electrical

Cyclic duration factor	100%		
Degree of protection	IP 65 as per DIN 40 050 and IEC 14 434/5		
Solenoid connector	Connector DIN 43 650/ISO 4400		
Position transducer connector	Special connector		
	without position control	with position control	with on-board electronics OBE
Solenoid current	max. 2.5 A	max. 2.7 A	40 VA max/24 V= nom. U _{D-E} = 0 ... +10 V see page 216
Coil resistance R ₂₀	3 Ω	2.7 Ω	
Max. power consumption at 100% load and operational temperature	30 VA max	40 VA max	

Static/Dynamic

Hysteresis	≤ 5%	≤ 1%	≤ 1%
Range of inversion	≤ 3%	≤ 0.5%	≤ 0.5%
Manufacturing tolerance for Q _{max.}	≈ 20%	≈ 5%	≈ 5%
Response time 100%/10% signal change	70/- ms	35/25 ms	25/25 ms
Response time with max. load change (pressure compensator)	≤ 30 ms	≤ 30 ms	≤ 30 ms

* only for position-controlled valves

All characteristic values in connection with proportional amplifiers

Valve with position control: QV 45

Valve without position control: 1 M 45 - 2.5 A

Valve with on-board electronics OBE: Conformity EN 50 081-1/EN 50 082-2



Caractéristiques

Générales

Construction	Distributeur à tiroir avec balance de pression incorporée
Commande, aimant à action proportionnelle	sans régulation de position, option commande manuelle de secours avec régulation de position, variante avec/sans amplificateur intégré OBE
Raccordement	Embase selon plan de pose NG 6 (ISO 4401)
Position de montage	indifférente
Température ambiante	-20 ... +50 °C
Vibrations	max. 25 g, 3 dimensions (24 h)
Condition du test version OBE	

Hydrauliques

Fluide	Fluide hydraulique selon norme DIN 51 524 ... 535, autre fluide sur demande					
Viscosité, conseillée	20 ... 100 mm ² /s					
max. admissible	10 ... 800 mm ² /s					
Température du fluide	-20 ... +80 °C (-20 ... +70 °C – OBE)					
Filtration	Classe de pollution admissible du fluide selon NAS 1638			Avec un filtre		
Selon sécurité de fonctionnement et durée de vie	8			β _x = 75		
	9			X = 10		
	10			20		
Sens d'écoulement	voir symbole					
Débit nominal [l/min]	Q _B réglé	2,6	7,5	10	15	35
	Q _A alimentation	–	30	50	–	40 ① / 50 ② ③
Q _{min.} réglé [cm ³ /min]*	10	–	40	45	50	
Pression de service max.	Orifice A, B: 250 bar (ou 100 bar) Orifice T: fermé Orifice P: fermé ou pression résiduelle 250 bar					
Perte de pression min. A → B	Q _{nom.} = 2,6 et 7,5 l/min: 4 ... 6 bar Q _{nom.} = 10 et 35 l/min: 10 ... 14 bar					

Electriques

Facteur de marche réelle	FM 100%		
Degré de protection	IP 65 selon norme DIN 40 050 et IEC 14 434/5		
Branchement électro-aimant	par prise selon norme DIN 43 650/ISO 4400		
Branchement du capteur de position	Prise spéciale		
Courant d'alimentation de l'électro-aimant	sans régulation de position	avec régulation de position	avec amplificateur intégré OBE
	max. 2,5 A	max. 2,7 A	40 VA max/24 V= nom.
			U _{D-E} = 0 ... +10 V
Résistance de bobine R ₂₀	3 Ω	2,7 Ω	voir page 216
Consommation max. pour charge 100% et température de service	30 VA max	40 VA max	

Statiques/Dynamiques

Hystérésis	≦ 5%	≦ 1%	≦ 1%
Seuil d'inversion	≦ 3%	≦ 0,5%	≦ 0,5%
Dispersion pour Q _{max.}	≈ 20%	≈ 5%	≈ 5%
Temps de réponse pour une course de 100%/10%	70/– ms	35/25 ms	25/25 ms
Temps de réponse en modification de charge maximum (comp. de pression)	≦ 30 ms	≦ 30 ms	≦ 30 ms

* uniquement pour les valves avec régulation de position

Toute caractéristique en liaison avec les amplificateurs électroniques proportionnels

Valve avec régulation de position: QV 45

Valve sans régulation de position: 1 M 45 – 2.5 A

Valve avec amplificateur intégré OBE: Conformité EN 50 081-1/EN 50 082-2

Kennlinien**Performance curves****Courbes caractéristiques** $v = 35 \text{ mm}^2/\text{s}$

① NO

 $Q_{\text{nom.}} = 7,5/15/35 \text{ l/min}$

Grundstellung offen

Basic position open

Position de repos ouvert

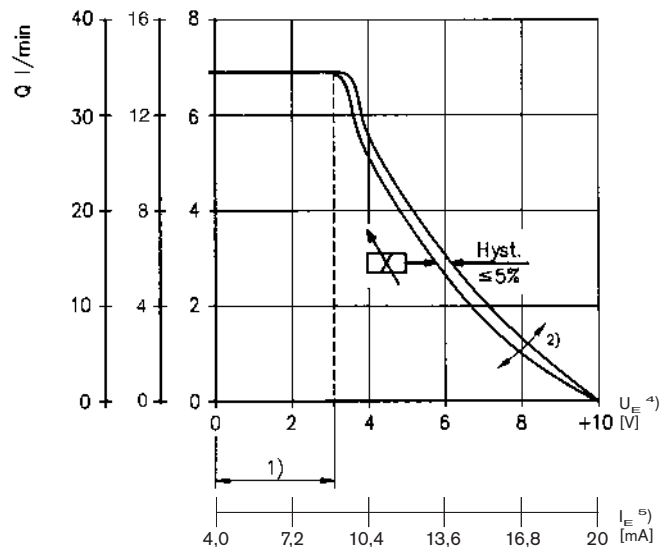

5

② NC

 $Q_{\text{nom.}} = 2,6 \text{ l/min, } p_{\text{max.}} = 100 \text{ bar}$ Sonderausführung für sehr geringe
Volumenströme

Special version for very low flow rates

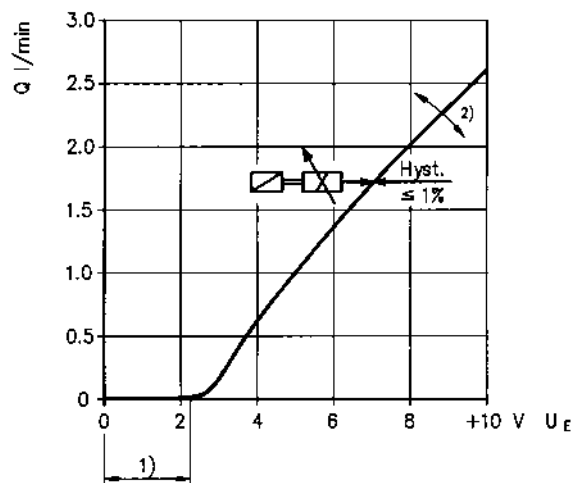
Exécution spéciale pour très
faibles débits

① ② ③ NC

 $Q_{\text{nom.}} = 7,5/10/35 \text{ l/min}$

Grundstellung geschlossen

Basic position closed

Position de repos fermé

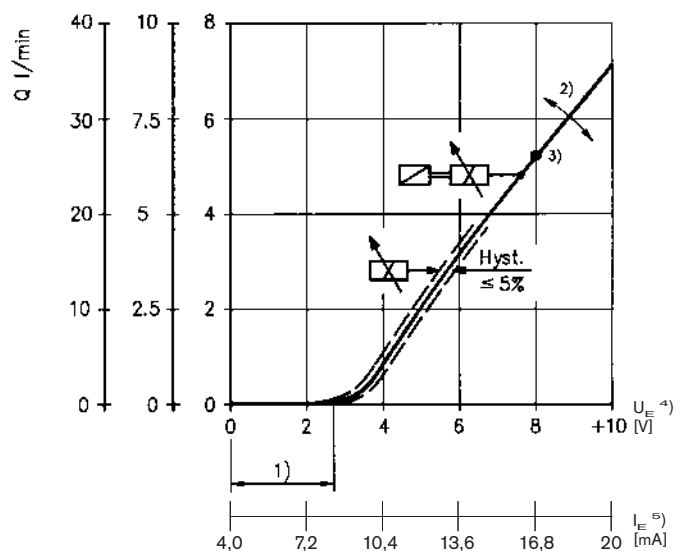
▶ **Ventilverstärker**

- 1) Nullpunkt-Justierung
- 2) Empfindlichkeits-Justierung
- 3) Werkeinstellung – OBE
±5% Exemplarstreuung
- 4) Version: $U_E = 0 \dots +10 \text{ V}$
- 5) Version: $I_E = 4 \dots 20 \text{ mA}$

▶▶ **Valve amplifier**

- 1) Zero adjustment
- 2) Gain adjustment
- 3) Factory setting – OBE
±5% manufacturing tolerance
- 4) Version: $U_E = 0 \dots +10 \text{ V}$
- 5) Version: $I_E = 4 \dots 20 \text{ mA}$

▶▶▶ **Amplificateur de valve**

- 1) Tarage du zéro
- 2) Tarage du gain
- 3) Réglage par l'usine – OBE
±5% dispersion
- 4) Version: $U_E = 0 \dots +10 \text{ V}$
- 5) Version: $I_E = 4 \dots 20 \text{ mA}$

2-Wege-Stromregelung

2-way flow control

Régulateur de débit à 2 voies

$Q_{nom} = 2,6 \text{ l/min}$

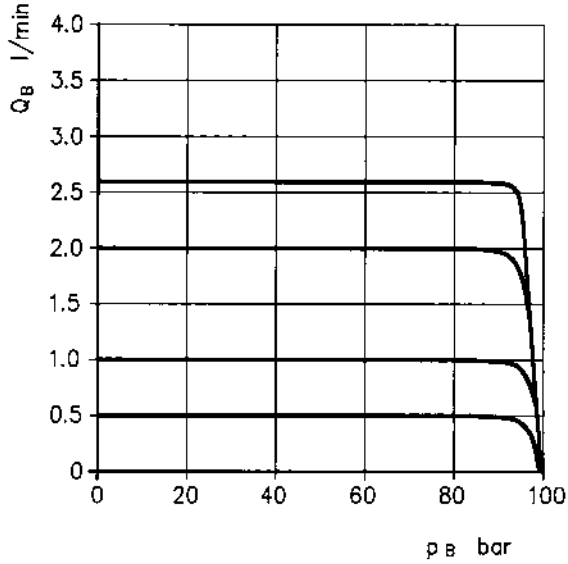
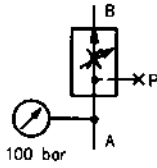

$Q_{nom} = 7,5/10/35 \text{ l/min}$

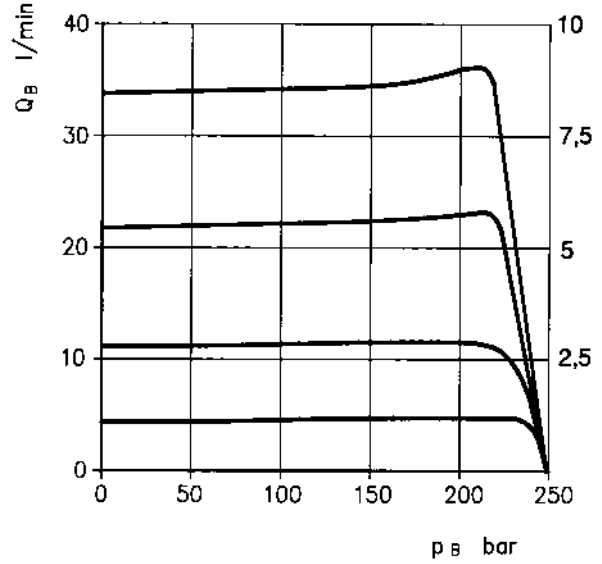
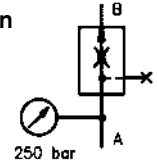

3-Wege-Stromregelung

3-way flow control

Régulateur de débit à 3 voies

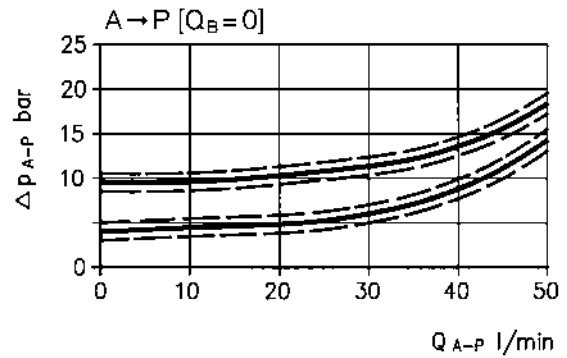
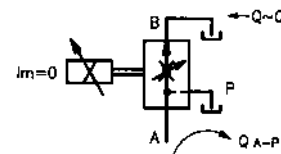
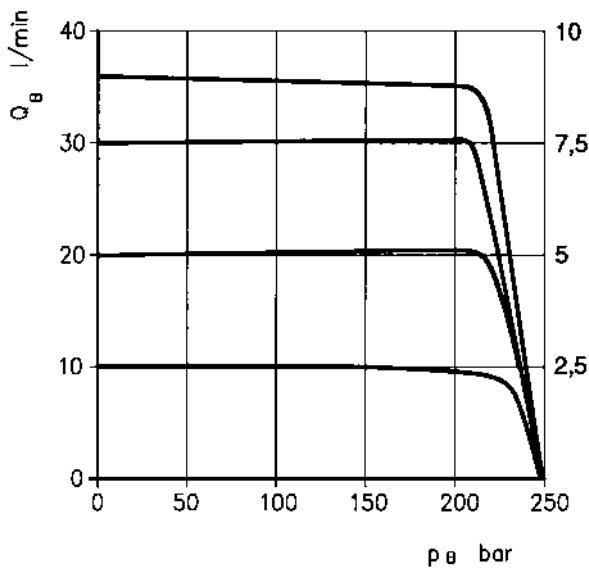
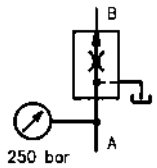

Abmessungen
Dimensions
Cotes d'encombrement

5

① mit Handnotbetätigung
with manual emergency override
avec commande manuelle de secours

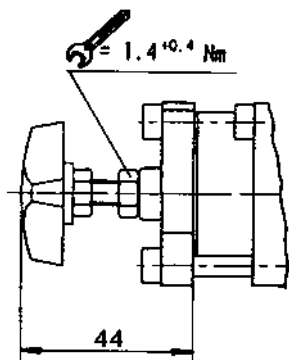

① ohne Lageregelung
without position control
sans régulation de position

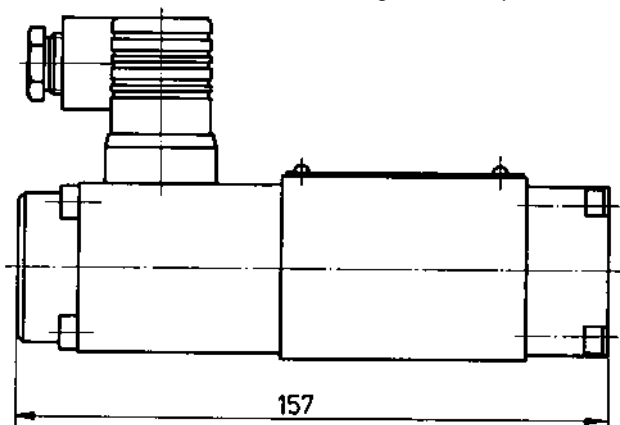

② mit Lageregelung
with position control
avec régulation de position

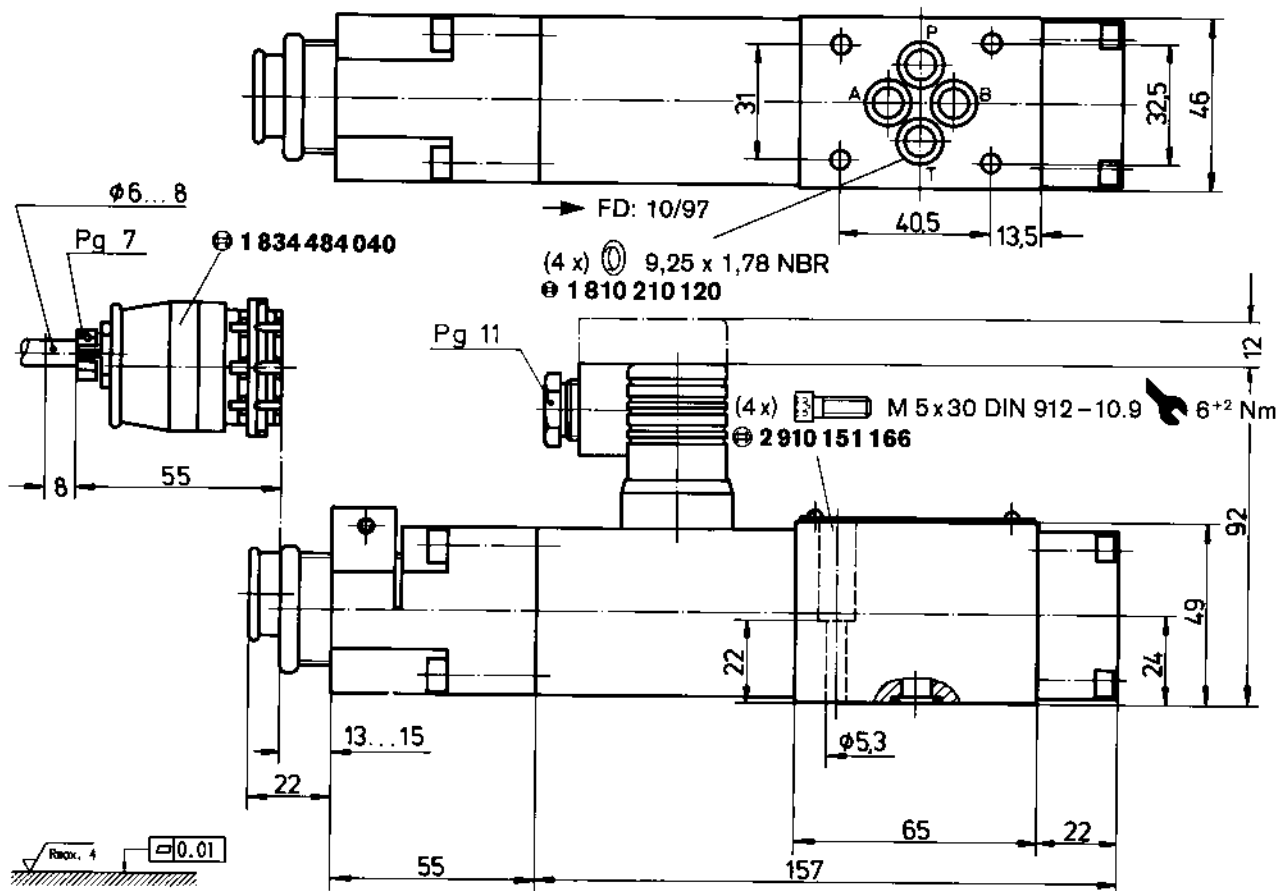

▶ Abmessungen des Anschlusslochbildes NG 6 ISO 4401
siehe Seite 212

▶▶ Dimensions of mounting hole configuration NG 6 ISO 4401
see page 212

▶▶▶ Cotes du plan de pose NG 6 ISO 4401
voir page 212

Abmessungen
Dimensions
Cotes d'encombrement

③ mit Lageregelung und eingebauter Elektronik – OBE
 with position control and on-board electronics – OBE
 avec régulation de position et amplificateur intégré – OBE

CE EN 50 081-1
 EN 50 082-2

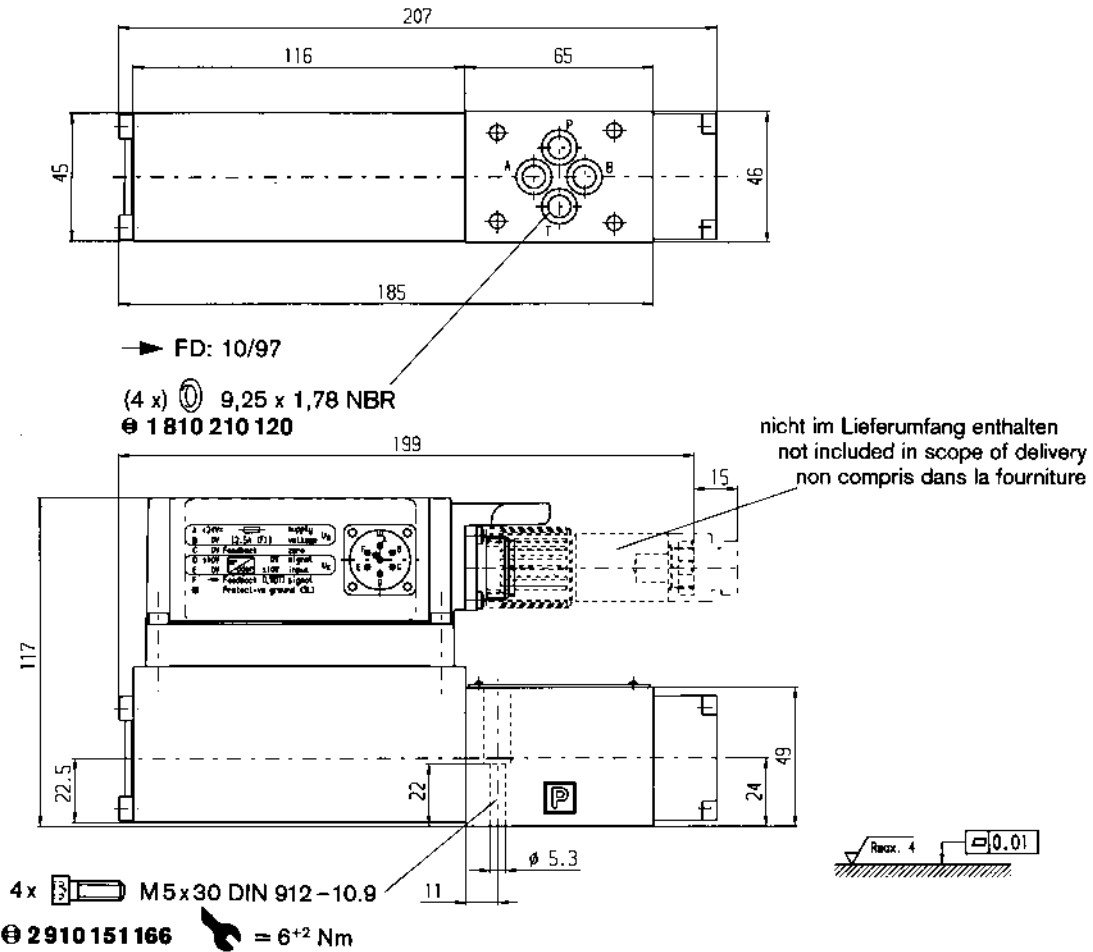

5

▶ Abmessungen des Anschlusslochbildes NG 6 ISO 4401 siehe Seite 212

▶▶ Dimensions of mounting hole configuration NG 6 ISO 4401 see page 212

▶▶▶ Cotes du plan de pose NG 6 ISO 4401 voir page 212

Steckerbelegung 7P
Pin assignment 7P
Affectation du connecteur 7P

Version: $U_E = 0 \dots +10 \text{ V}$
 $R_i = 100 \text{ k}\Omega$

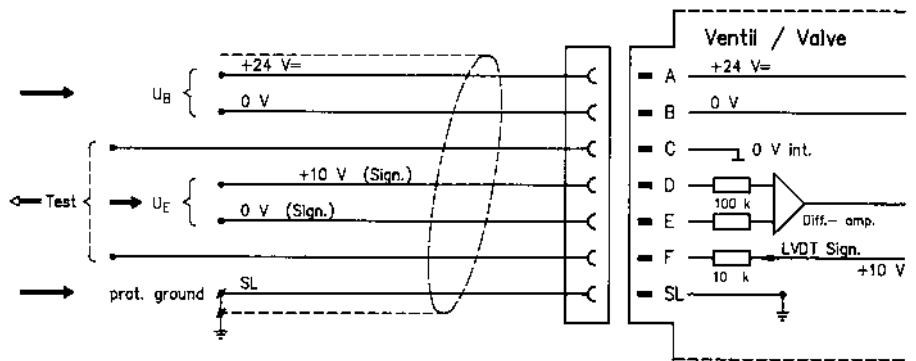

Version: $I_E = 4 \dots 20 \text{ mA}$
 Bürde = 200 Ω
 Load
 Charge

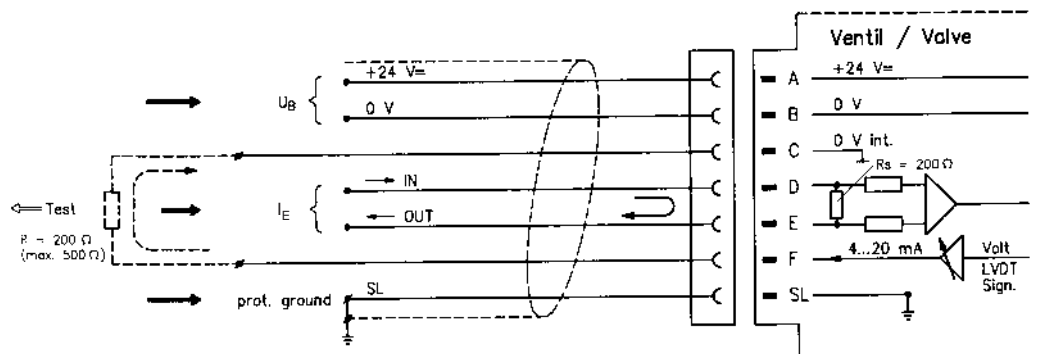

NG 10







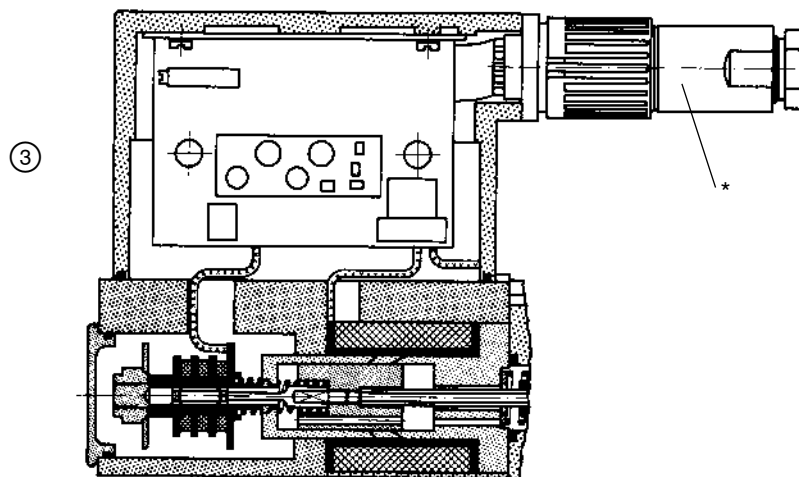
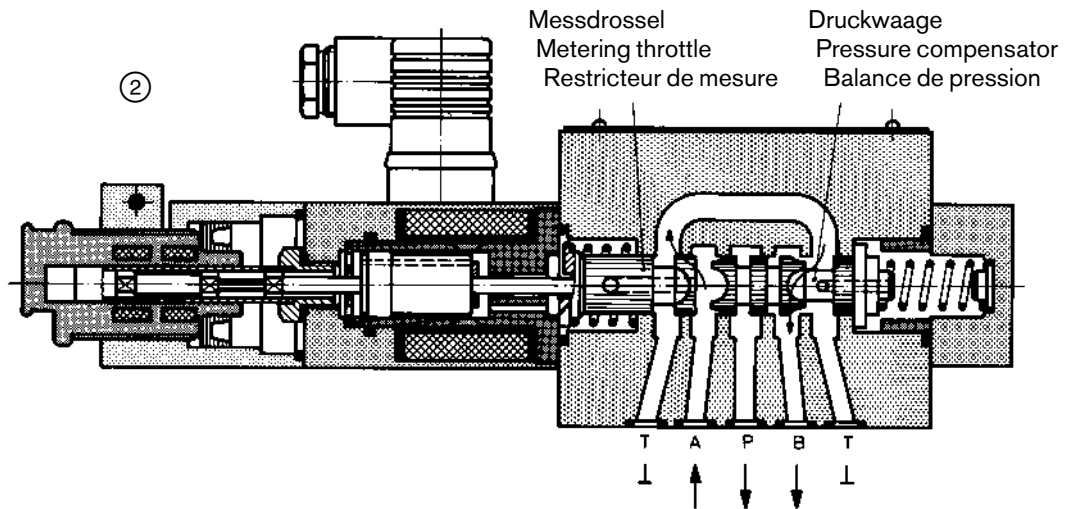
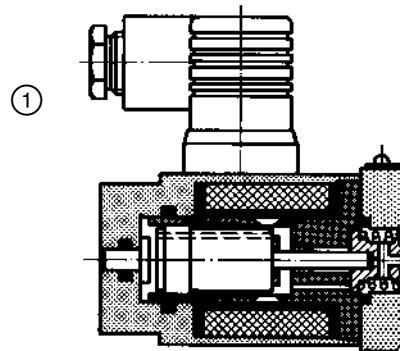
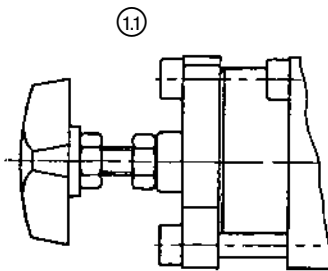

Stromregelventile Flow control valves Régulateurs de débit

Funktion
Function
Fonction

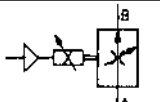
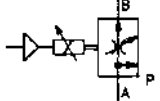
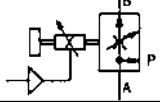
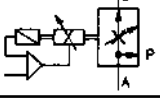
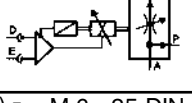

Weitere Fotos siehe Seite 126
Further photos see page 126
Autres photos voir page 126

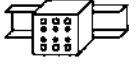

Sinnbild Symbol Symbole	 A/VA max	Δp [bar]	Q: A → B [l/min] Q _A Q _B		p _{max.} [bar]		[kg]	Ⓢ
①  NO	2,5/30	8	-	70	250	1-P 2-P 1-M 1-K	5,8	0 811 403 013
①  NC		8	65	60			5,8	0 811 403 010
①  NC		8	65	60			6,0	0 811 403 011
②  NC	2,7/40	8	100	70		2-K 3-K 4-K	6,0	0 811 403 012
③  OBE NC	24 V= 40 VA max U _{D-E} = 0 ... +10 V	8	100	70			6,9	0 811 403 019
(4 x)  M 6 x 35 DIN 912-10.9								2 910 151 207
P 	246	 Seite Page	AS 2.5 - V		1-P	0,15	0 811 405 143	
			AS 2.5 - mA		2-P	0,15	0 811 405 145	
M 	253		1 M 2.5 - RGC1		1-M	0,25	0 811 405 127	
K 	266		1 M 45 - 2.5 A		1-K	0,2	0 811 405 079	
		QV 45		2-K	0,2	0 811 405 098		
		QV 45 - RGC1		3-K	0,2	0 811 405 103		
		QV 45 - RGC3		4-K	0,3	B 830 303 389		
* 	Stecker 7-polig Plug 7-pole Connecteur 7 pôles Seite Page 241	KS				1 834 482 022		
		KS				1 834 482 026		
		MS				1 834 482 023		
		MS				1 834 482 024		
		KS 90°				1 834 484 252		

▶ NO - Bypass-Regelung =
2-Wege-Funktion
NC - Zulauf-Regelung =
3-Wege-Funktion

▶▶ NO - Bypass control =
2-way function
NC - Supply control =
3-way function

▶▶▶ NO - régulation by-pass =
fonction 2 voies
NC - régulation alimentation =
fonction 3 voies

Allgemein

Stromregelventile NG 10 sind direkt betätigte Drosselventile mit eingebauter Druckwaage.

Durchflussrichtung

Proportional-Stromregelventile mit Grundstellung geschlossen können wahlweise als 2-Wege- oder als 3-Wege-Stromregelventile verwendet werden.

Stromregelventile mit Grundstellung offen können nur als 2-Wege-Stromregelventile verwendet werden.

General

Flow control valves NG 10 are directly operated throttle valves with integrated pressure compensator.

Flow direction

Proportional flow control valves with closed basic position may be used either as 2-way or 3-way flow control valves.

Flow control valves with open basic position may only be used as 2-way flow control valves.

Généralités

Les régulateurs de débit NG 10 sont des limiteurs de débit à commande directe avec balance de pression incorporée.

Sens de passage

Les régulateurs de débit proportionnels fermés en position de repos peuvent être utilisés au choix en tant que régulateurs de débit à 2 ou 3 voies.

Les régulateurs de débit restant ouverts en position de repos ne peuvent être utilisés qu'en tant que régulateurs de débit à 2 voies.

2-Wege-Stromregelung

2-way flow control

Régulateur de débit à 2 voies

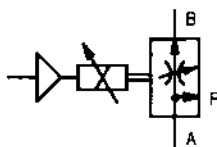

3-Wege-Stromregelung

3-way flow control

Régulateur de débit à 3 voies

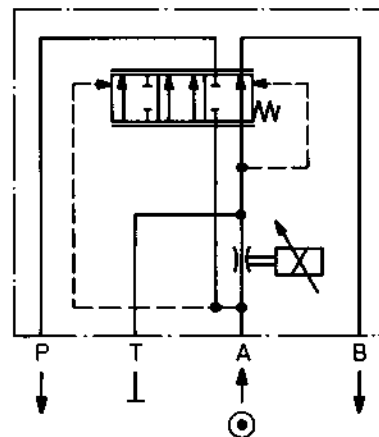
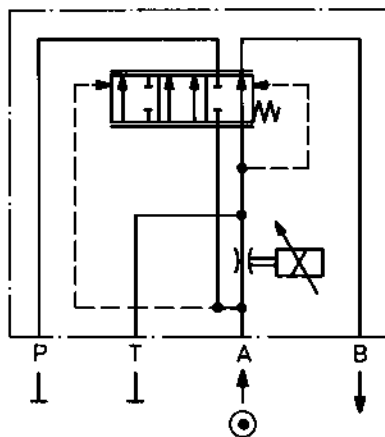
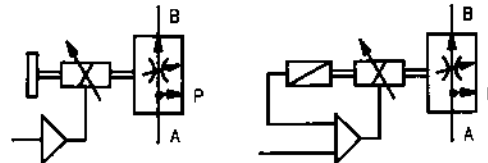

2-Wege-Stromregelventil

A: Zulauf
B: Ablauf
P: } verschlossen
T: }

2-way flow control valve

A: Supply
B: Discharge
P: } closed
T: }

Régulateur de débit à 2 voies

A: Alimentation
B: Evacuation
P: } obturés
T: }

3-Wege-Stromregelventil

A: Zulauf
B: Ablauf
P: Reststrom, belastbar bis 250 bar, oder Tank
T: verschlossen

3-way flow control valve

A: Supply
B: Discharge
P: Residual flow, can withstand up to 250 bar, or reservoir
T: closed

Régulateur de débit à 3 voies

A: Alimentation
B: Evacuation
P: Pression résiduelle, charge admissible jusqu'à 250 bar, ou réservoir
T: obturé

Kenngrößen

Allgemein

Bauart	Schieberventil mit integrierter Druckwaage
Betätigung, Proportionalmagnet	ohne Lageregelung, Option Handnotverstellung mit Lageregelung, Varianten mit/ohne eingebauter Elektronik OBE
Anschlussart	Plattenanschluss, Lochbild NG 10 (ISO 4401)
Einbaulage	beliebig
Umgebungstemperatur	-20 ... +50 °C
Rüttelfestigkeit	max. 25 g, Raumschüttelprüfung in allen Richtungen (24 h)
Prüfbedingung Version OBE	

Hydraulisch

Druckmittel	Hydrauliköl nach DIN 51 524 ... 535, andere Medien nach Rückfrage			
Viskosität, empfohlen max. zulässig	20 ... 100 mm ² /s			
	10 ... 800 mm ² /s			
Druckmitteltemperatur	-20 ... +80 °C (-20 ... +70 °C - OBE)			
Filterung	Zulässige Verschmutzungs- klasse des Druckmittels nach NAS 1638	Zu erreichen mit Filter $\beta_x = 75$		
	8	X = 10		
	9	20		
	10	25		
Entsprechend Betriebssicherheit und Lebensdauer				
Durchflussrichtung	siehe Sinnbild			
Nenndurchfluss [l/min]	Q_B geregelt	80	60	80
	Q_A Zulauf	- NO ①	65 NC ①	100 NC ② ③
Max. Betriebsdruck	Anschluss A, B: 250 bar Anschluss T: verschlossen Anschluss P: verschlossen oder Reststrom 250 bar			
Mindestdruckgefälle	8 bar			

Elektrisch

Relative Einschaltdauer	100% ED		
Schutzart	IP 65 nach DIN 40 050 und IEC 14 434/5		
Anschluss Magnet	Gerätesteckdose DIN 43 650/ISO 4400		
Anschluss Wegaufnehmer	Spezialsteckdose		
Magnetstrom	ohne Lageregelung	mit Lageregelung	mit eingebauter Elektronik OBE
	max. 2,5 A	max. 2,7 A	40 VA max/24 V= nom.
	3 Ω	2,7 Ω	$U_{D-E} = 0 \dots +10 \text{ V}$
	30 VA max	40 VA max	siehe Seite 216
Spulenwiderstand R_{20}			
Max. Leistungsaufnahme bei 100% Last und Betriebstemperatur			

Statisch/Dynamisch

Hysterese	≦ 5%	≦ 1%	≦ 1%
Umkehrspanne	≦ 3%	≦ 0,5%	≦ 0,5%
Exemplarstreuung für Q_{max}	≈ 20%	≈ 5%	≈ 5%
Stellzeit 100%/10% Signalsprung	70/- ms	35/25 ms	35/25 ms
Ausregelzeit bei max. Laständerung (Druckwaage)	≦ 45 ms	≦ 45 ms	≦ 45 ms

Alle Kenngrößen in Verbindung mit Proportionalverstärkern

Ventil mit Lageregelung: QV 45

Ventil ohne Lageregelung: 1 M 45 - 2.5 A

Ventil mit eingebauter Elektronik OBE: Konformität EN 50 081-1/EN 50 082-2



Characteristics

General

Construction	Spool type valve with integrated pressure compensator
Actuation, proportional solenoid	without position control, optional manual emergency override with position control, variants with/without on-board electronics OBE
Connection type	Subplate connection, mounting hole configuration NG 10 (ISO 4401)
Mounting position	optional
Ambient temperature range	-20 ... +50 °C
Vibration	max. 25 g, shaken in 3 dimensions (24 h)
Test condition version OBE	

Hydraulic

Pressure medium	Hydraulic oil as per DIN 51 524 ... 535, other fluids after prior consultation			
Viscosity, recommended	20 ... 100 mm ² /s			
max. permitted	10 ... 800 mm ² /s			
Pressure medium temperature	-20 ... +80 °C (-20 ... +70 °C - OBE)			
Filtration	Permissible contamination class of pressure medium as per NAS 1638	Achieved using filter		
In line with operational reliability and service life	8	β _x = 75		
	9	X = 10		
	10	20		
	10	25		
Flow direction	cf. symbol			
Nominal flow [l/min]	Q _B controlled	80	60	80
	Q _A supply	- NO ①	65 NC ①	100 NC ② ③
Max. working pressure	Port A, B: 250 bar Port T: closed Port P: closed or 250 bar residual flow			
Min. pressure drop	8 bar			

Electrical

Cyclic duration factor	100%		
Degree of protection	IP 65 as per DIN 40 050 and IEC 14 434/5		
Solenoid connector	Connector DIN 43 650/ISO 4400		
Position transducer connector	Special connector		
Solenoid current	without position control	with position control	with on-board electronics OBE
	max. 2.5 A	max. 2.7 A	40 VA max/24 V= nom.
	Coil resistance R ₂₀	3 Ω	2.7 Ω
Max. power consumption at 100% load and operational temperature	30 VA max	40 VA max	see page 216

Static/Dynamic

Hysteresis	≤ 5%	≤ 1%	≤ 1%
Range of inversion	≤ 3%	≤ 0.5%	≤ 0.5%
Manufacturing tolerance for Q _{max.}	≈ 20%	≈ 5%	≈ 5%
Response time 100%/10% signal change	70/- ms	35/25 ms	35/25 ms
Response time with max. load change (pressure compensator)	≤ 45 ms	≤ 45 ms	≤ 45 ms

All characteristic values in connection with proportional amplifiers

Valve with position control: QV 45

Valve without position control: 1 M 45 - 2.5 A

Valve with on-board electronics OBE: Conformity EN 50 081-1/EN 50 082-2



Caractéristiques

Générales

Construction	Distributeur à tiroir avec balance de pression incorporé
Commande, aimant à action proportionnelle	sans régulation de position, option commande manuelle de secours avec régulation de position, variante avec/sans amplificateur intégré OBE
Raccordement	Embase selon plan de pose NG 10 (ISO 4401)
Position de montage	indifférente
Température ambiante	-20 ... +50 °C
Vibrations	max. 25 g, 3 dimensions (24 h)
Condition du test version OBE	

Hydrauliques

Fluide	Fluide hydraulique selon norme DIN 51 524 ... 535, autre fluide sur demande			
Viscosité, conseillée	20 ... 100 mm ² /s			
max. admissible	10 ... 800 mm ² /s			
Température du fluide	-20 ... +80 °C (-20 ... +70 °C - OBE)			
Filtration	Classe de pollution admissible du fluide selon NAS 1638	Avec un filtre $\beta_x = 75$		
Selon sécurité de fonctionnement et durée de vie	8	X = 10		
	9	20		
	10	25		
Sens d'écoulement	voir symbole			
Débit nominal [l/min]	Q_B réglé	80	60	80
	Q_A alimentation	- NO ①	65 NC ①	100 NC ② ③
Pression de service max.	Orifice A, B: 250 bar Orifice T: fermé Orifice P: fermé ou pression résiduelle 250 bar			
Perte de pression min.	8 bar			

Electriques

Facteur de marche réelle	FM 100%		
Degré de protection	IP 65 selon norme DIN 40 050 et IEC 14 434/5		
Branchement électro-aimant	par prise selon norme DIN 43 650/ISO 4400		
Branchement du capteur de position	Prise spéciale		
Courant d'alimentation de l'électro-aimant	sans régulation de position	avec régulation de position	avec amplificateur intégré OBE
	max. 2,5 A	max. 2,7 A	40 VA max/24 V= nom.
	3 Ω	2,7 Ω	$U_{D-E} = 0 \dots +10 V$
	30 VA max	40 VA max	voir page 216
Résistance de bobine R_{20}			
Consommation max. pour charge 100% et température de service			

Statiques/Dynamiques

Hystérésis	$\leq 5\%$	$\leq 1\%$	$\leq 1\%$
Seuil d'inversion	$\leq 3\%$	$\leq 0,5\%$	$\leq 0,5\%$
Dispersion pour Q_{max}	$\approx 20\%$	$\approx 5\%$	$\approx 5\%$
Temps de réponse pour une course de 100%/10%	70/- ms	35/25 ms	35/25 ms
Temps de réponse en modification de charge maximum (comp. de pression)	$\leq 45 ms$	$\leq 45 ms$	$\leq 45 ms$

Toute caractéristique en liaison avec les amplificateurs électroniques proportionnels

Valve avec régulation de position: QV 45

Valve sans régulation de position: 1 M 45 - 2.5 A

Valve avec amplificateur intégré OBE: Conformité EN 50 081-1/EN 50 082-2

Kennlinien

Performance curves

Courbes caractéristiques

$\nu = 35 \text{ mm}^2/\text{s}$

① NO

$Q_{\text{nom.}} = 80 \text{ l/min}$

Grundstellung offen

Basic position open

Position de repos ouvert

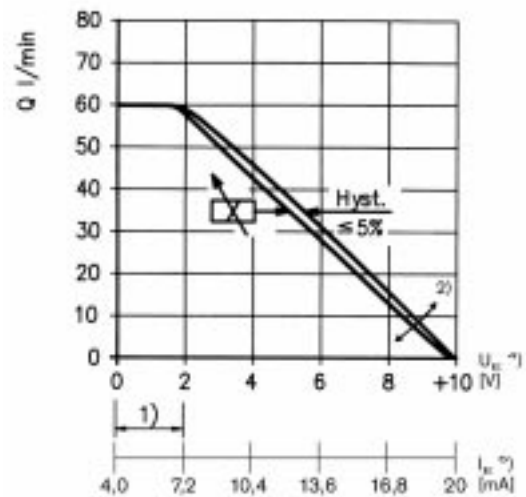

② NC

$Q_{\text{nom.}} = 60 \text{ l/min}$

Grundstellung geschlossen

Basic position closed

Position de repos fermé

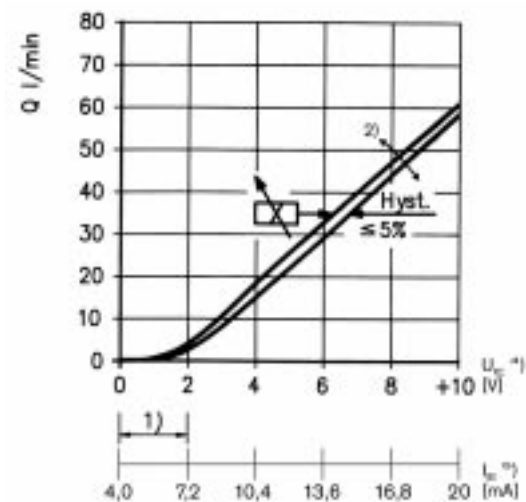

③ NC

$Q_{\text{nom.}} = 80 \text{ l/min}$

Grundstellung geschlossen

Basic position closed

Position de repos fermé

3) Version OBE: - - - - -

$Q_N 70 \text{ l/min (} U_{D-E} +10 \text{ V)}$

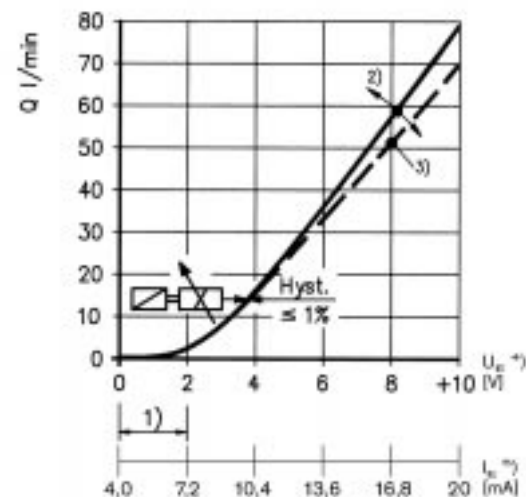

Ventilverstärker

- 1) Nullpunkt-Justierung
- 2) Empfindlichkeits-Justierung
- 3) Werkeinstellung – OBE
 $\pm 5\%$ Exemplarstreuung
- 4) Version: $U_E = 0 \dots +10 \text{ V}$
- 5) Version: $I_E = 4 \dots 20 \text{ mA}$

Valve amplifier

- 1) Zero adjustment
- 2) Gain adjustment
- 3) Factory setting – OBE
 $\pm 5\%$ manufacturing tolerance
- 4) Version: $U_E = 0 \dots +10 \text{ V}$
- 5) Version: $I_E = 4 \dots 20 \text{ mA}$

Amplificateur de valve

- 1) Tarage du zéro
- 2) Tarage du gain
- 3) Réglage par l'usine – OBE
 $\pm 5\%$ dispersion
- 4) Version: $U_E = 0 \dots +10 \text{ V}$
- 5) Version: $I_E = 4 \dots 20 \text{ mA}$

2-Wege-Stromregelung

2-way flow control

Régulateur de débit à 2 voies

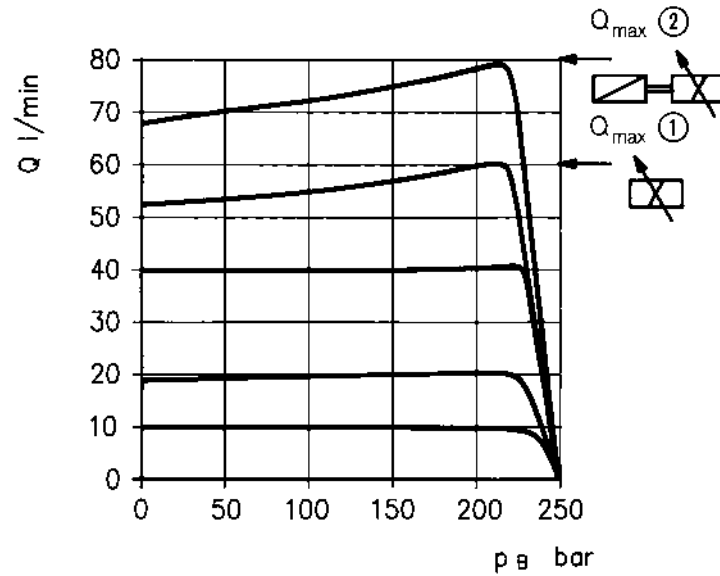
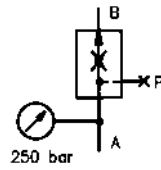

3-Wege-Stromregelung

3-way flow control

Régulateur de débit à 3 voies

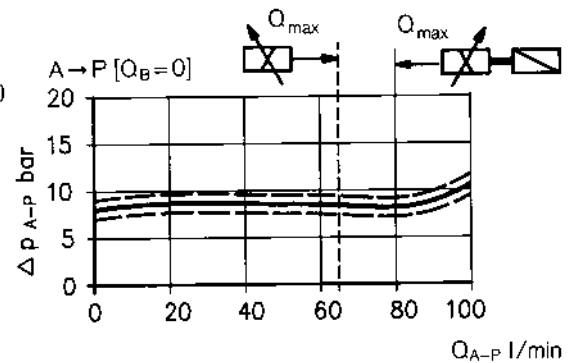
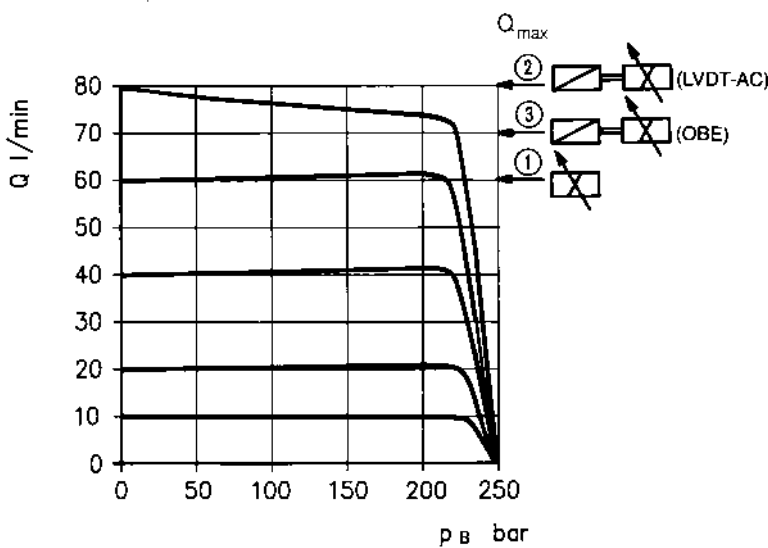
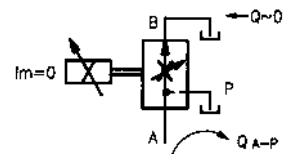
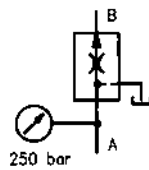

Abmessungen
Dimensions
Cotes d'encombrement

① mit Handnotbetätigung
with manual emergency override
avec commande manuelle de secours

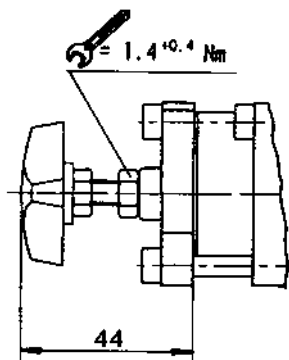

① ohne Lageregelung
without position control
sans régulation de position

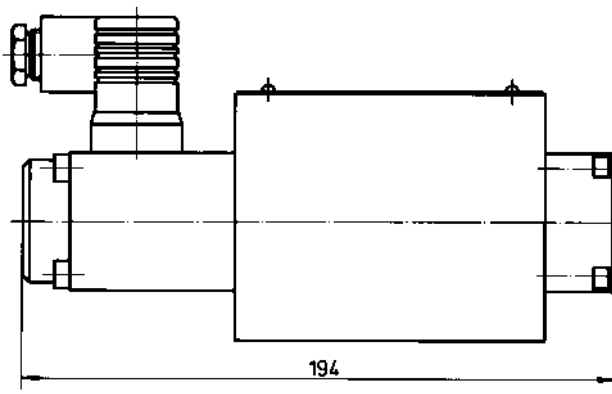

② mit Lageregelung
with position control
avec régulation de position

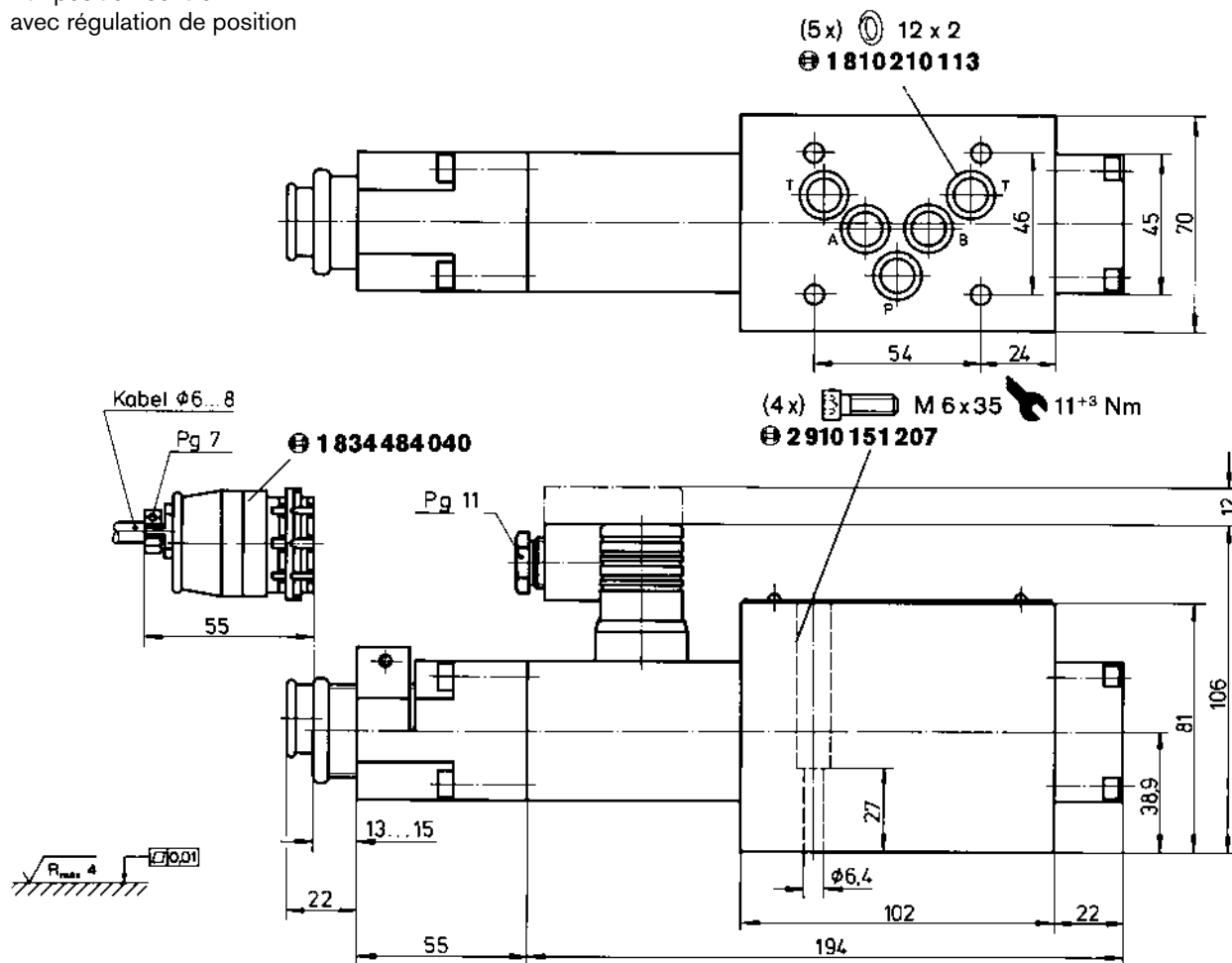

▶ Abmessungen des Anschlusslochbildes NG 10 ISO 4401
siehe Seite 212

▶▶ Dimensions of mounting hole configuration NG 10 ISO 4401
see page 212

▶▶▶ Cotes du plan de pose NG 10 ISO 4401
voir page 212

Abmessungen
Dimensions
Cotes d'encombrement

③ mit Lageregelung und eingebauter Elektronik – OBE
 with position control and on-board electronics – OBE
 avec régulation de position et amplificateur intégré – OBE

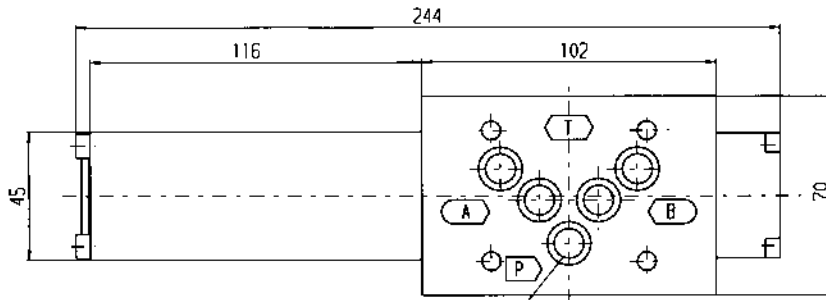
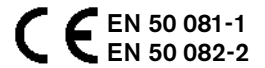

(5 x) \varnothing 12 x 2
 1810210113

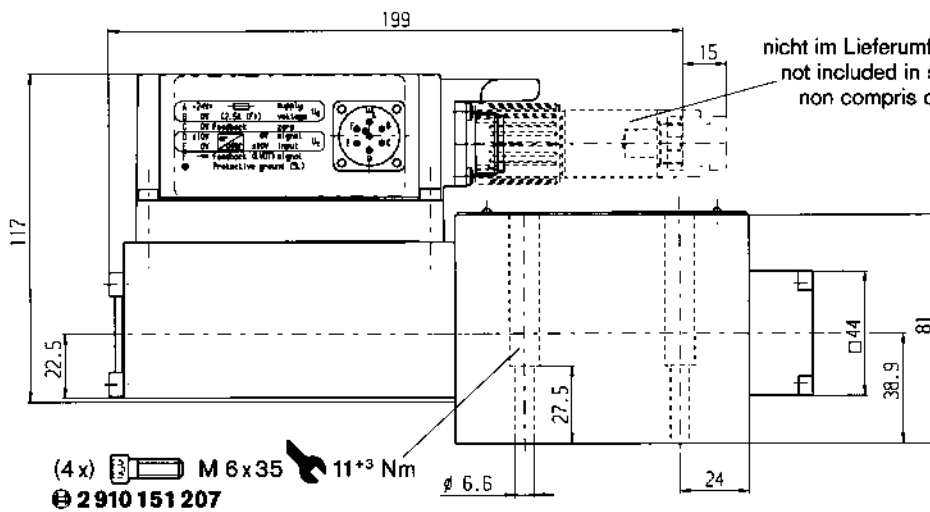

nicht im Lieferumfang enthalten
 not included in scope of delivery
 non compris dans la fourniture

(4 x) M 6 x 35 11^{+3} Nm
 2910151207

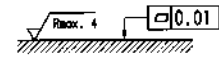

► Abmessungen des Anschlusslochbildes NG 10 ISO 4401
 siehe Seite 212

►► Dimensions of mounting hole configuration NG 10 ISO 4401
 see page 212

►►► Cotes du plan de pose NG 10 ISO 4401
 voir page 212

Steckerbelegung 7P
Pin assignment 7P
Affectation du connecteur 7P

Version: $U_E = 0 \dots +10$ V
 $R_i = 100$ k Ω

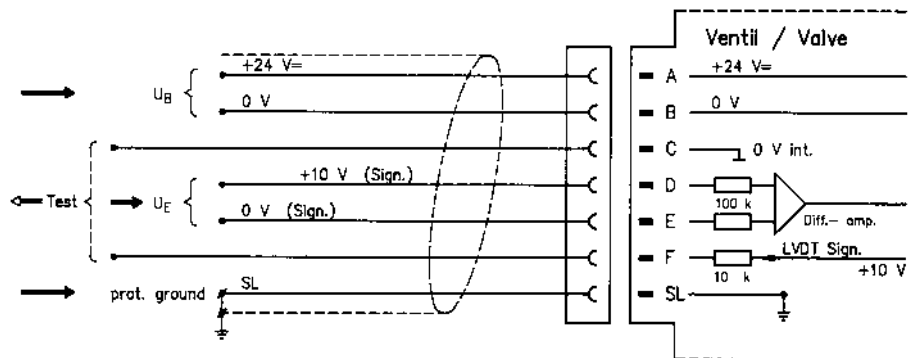

Version: $I_E = 4 \dots 20$ mA
 Bürde = 200 Ω
 Load Charge

