

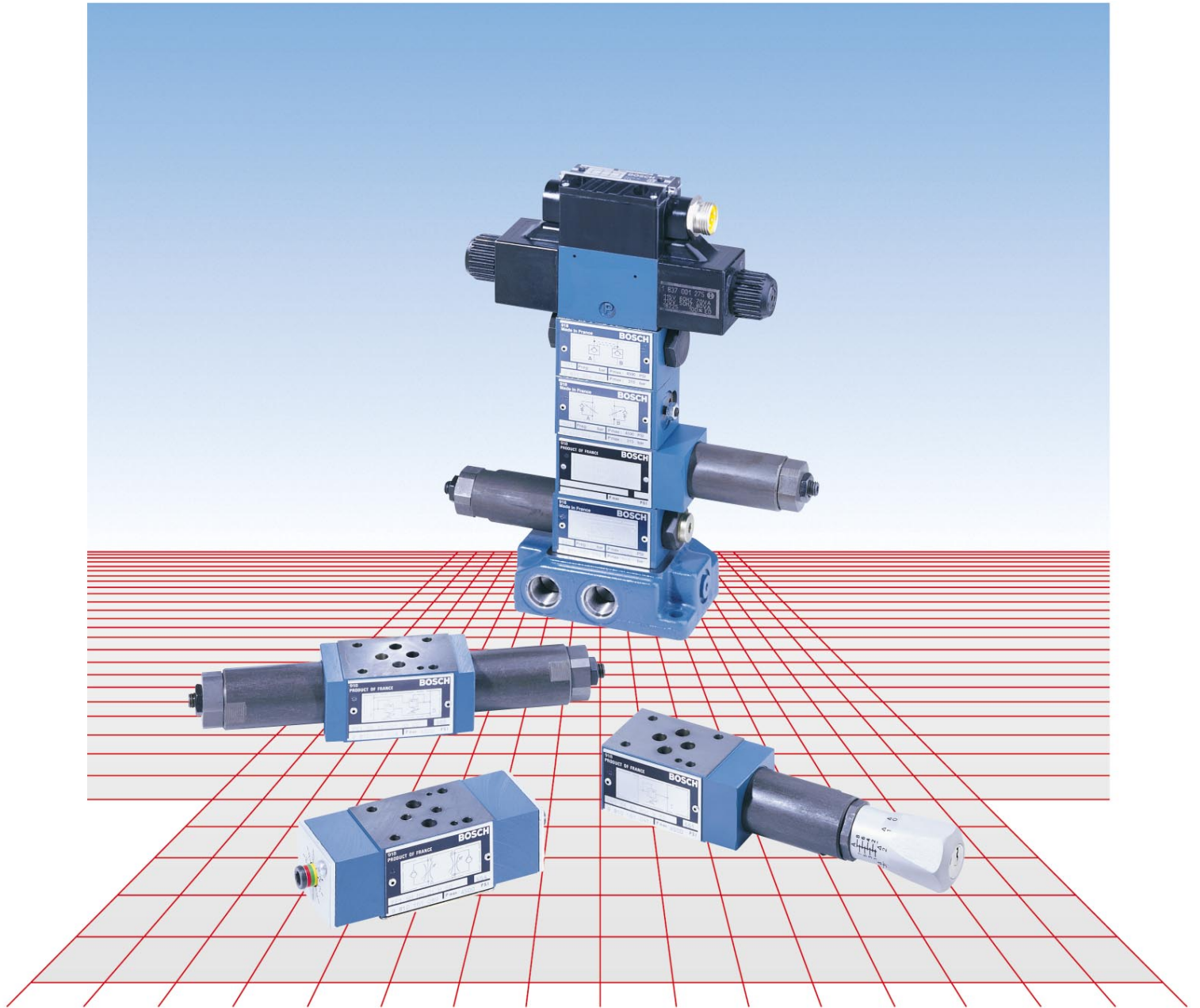

BOSCH

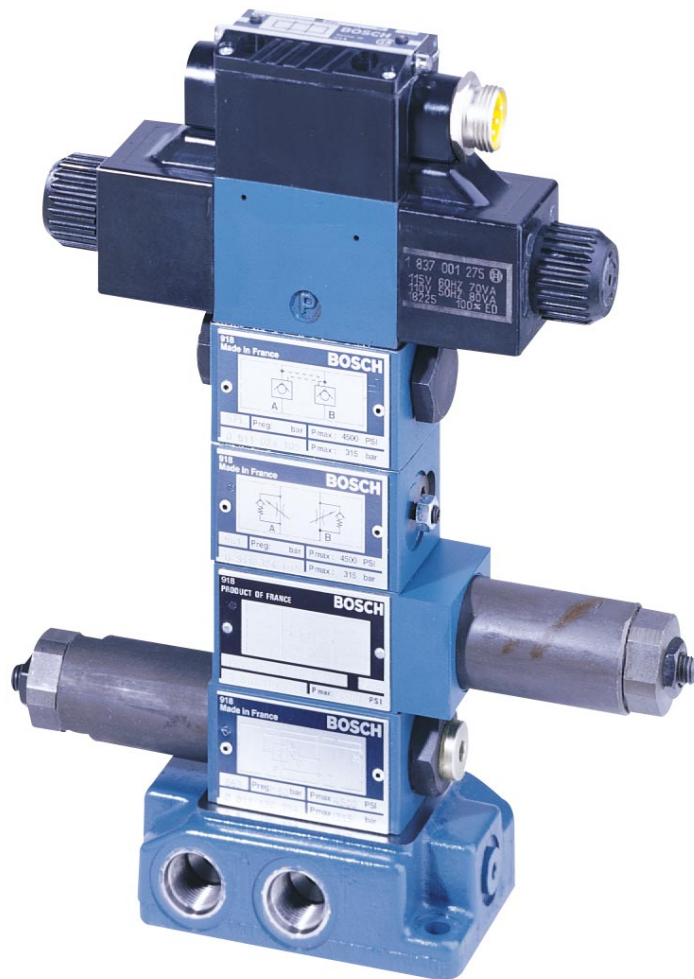

Modular Valves
D03 (NG 6)
315 bar
10



D03 (NG-6) Modular Valves

The Racine Bosch Group Modular Valves are engineered and manufactured with the same quality and experience as the proportional valves. This dedication to quality and performance will provide you with the following features.

Valve Features:

- NFPA and ISO 4401 Standard Subplate Mounting
- CETOP Standard Dimensions
- Pressure Rated to 4600 PSI (315 bar)
- Flow rated to 13.2 - 15.8 GPM (50 - 60 l/min.)
- Available Modules:
 - Six Pressure Relief
 - Three Pressure Reducing/Receiving
 - Four Flow Control
 - Five Check
- Adjustment Options:
 - Hex Key
 - Lockable Key
- All Steel Construction
- Viton Seals Standard

Overview:

The purpose of this information is to introduce and to outline the differences in the new modular product line from Racine Fluid Power. This line of modules has been tried and proven in Europe and will replace the Racine modules.

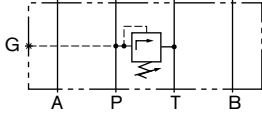
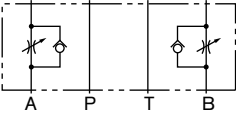
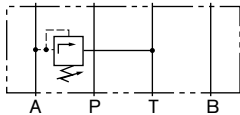
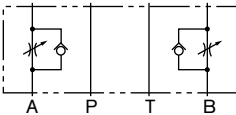
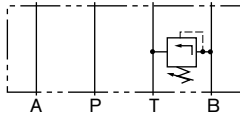
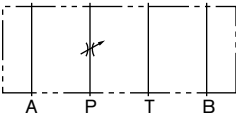
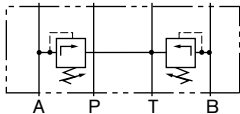
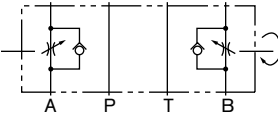
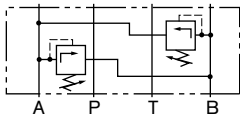
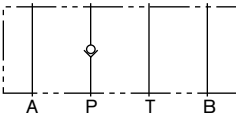
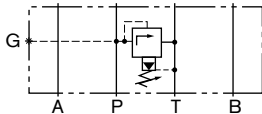
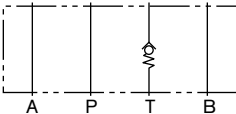
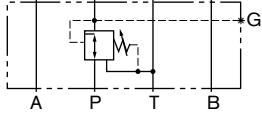
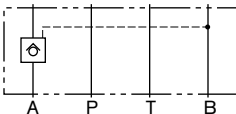
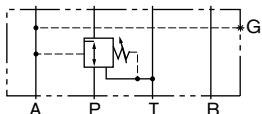
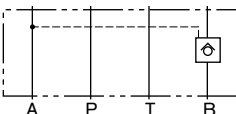
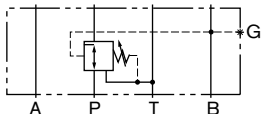
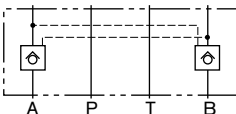



PRESSURE RELIEF VALVES	PAGE	FLOW CONTROL VALVES	PAGE
	2	 <p>meter-out</p>	13
	2	 <p>meter-in</p>	13
	2		16
	2	 <p>meter-in or meter-out</p>	16
	2	<p>CHECK VALVES</p> 	19
	6		19
<p>PRESSURE REDUCING VALVES</p> 	10		19
	10		19
	10		19

**Pressure relief valves
direct acting**

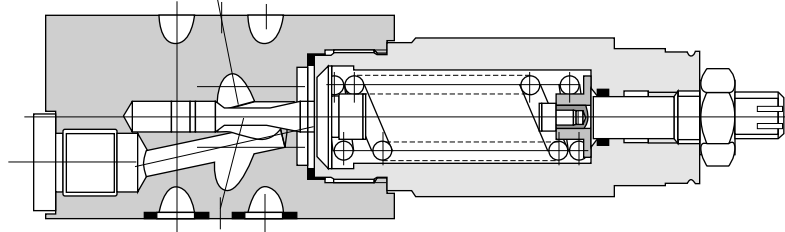

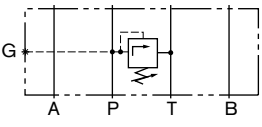
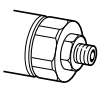
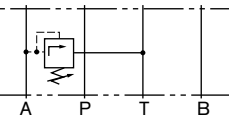
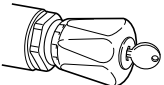
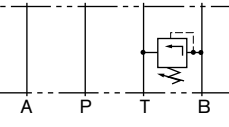
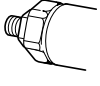
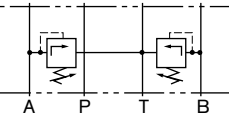
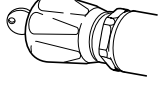
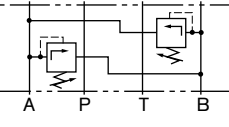
Function

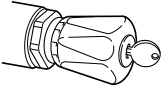
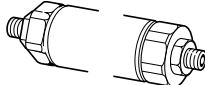
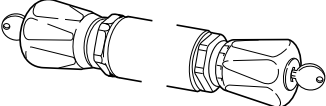

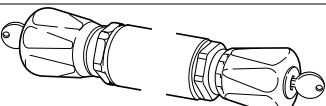
Symbol	Adjustment	P. nom. PSI (bar)	Dimensions	Lbs. (kg)	
		60-1160 (4 ... 80)	1.1	3 (1.4)	9 810 161 176 9 810 161 177 9 810 161 178
		300-2300 (20 ... 160)			
		300-4500 (20 ... 315)			
		60-1160 (4 ... 80)	1.2		9 810 161 175
		60-1160 (4 ... 80)	2.1		9 810 161 180 9 810 161 181 9 810 161 182
		300-2300 (20 ... 160)			
		300-4500 (20 ... 315)			
		60-1160 (4 ... 80)	2.2		9 810 161 179
		60-1160 (4 ... 80)	1.3		9 810 161 184 9 810 161 185 9 810 161 186
		300-2300 (20 ... 160)			
		300-4500 (20 ... 315)			
		60-1160 (4 ... 80)	1.4		9 810 161 183
		60-1160 (4 ... 80)	2.3		9 810 161 188 9 810 161 189 9 810 161 190
		300-2300 (20 ... 160)			
		300-4500 (20 ... 315)			
		60-1160 (4 ... 80)	2.4		9 810 161 187
		60-1160 (4 ... 80)	2.3		9 810 161 192 9 810 161 193 9 810 161 194
		300-2300 (20 ... 160)			
		300-4500 (20 ... 315)			
		60-1160 (4 ... 80)	2.4		9 810 161 191



Pressure relief valves direct acting

Specifications	
Valve function	Pressure relief valve, direct operated
Mounting type	Intermediate plate D03 (NG 6, ISO 4401)
Mounting position	Optional
Fluid	Petroleum, fire resistant, HWCF
Viscosity	60 . . . 2300 SUS (10 - 500cSt)
Fluid-temperature	-4 . . . 175°F (-20 to 80°C)
Filtration	Contamination class 10: according to NAS 1638 ISO/DIS 4406, class 19116 can be realized with filter $\beta_{25} = 75^*$
Seals	Fluorocarbon (Viton®)
Max. setting pressure	1160, 2300, 4500 PSI
Max. input pressure	4600 PSI (315 bar)
Max. flow	15.8 gpm (60 l/min.)

PRODUCT LITERATURE DISCLAIMER
SPECIFICATIONS AND/OR DIMENSIONS ARE SUBJECT TO CHANGE WITHOUT PRIOR NOTICE. PLEASE CONSULT FACTORY.

* Dirt particles retention rate > 25 µm is 1 = 75, ie. 98.6%.

Performance curves
v = 35mm²/s, P = 250 bar

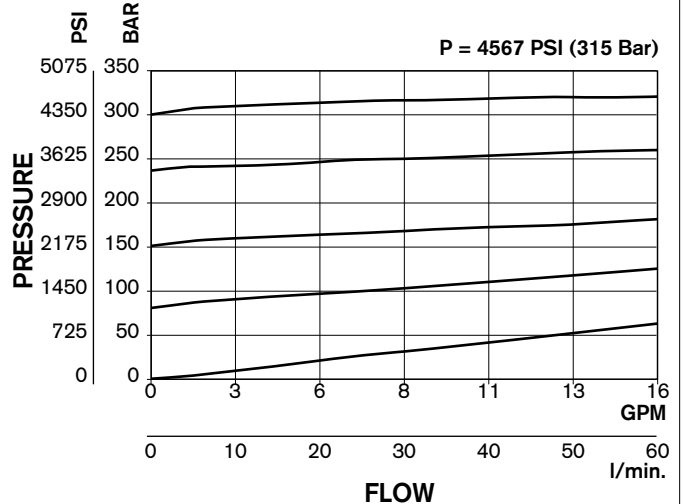
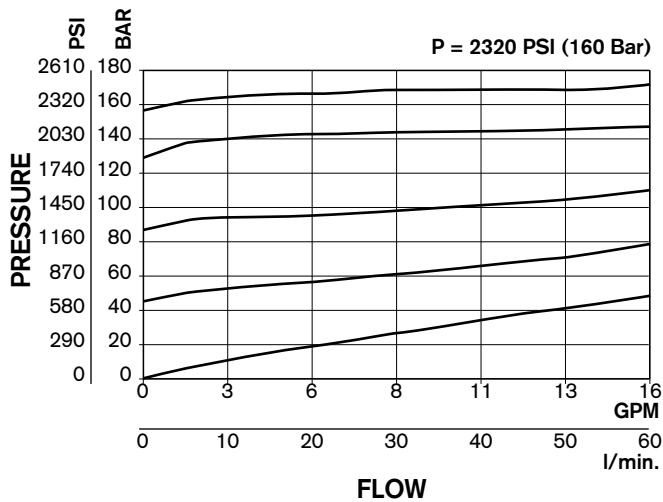
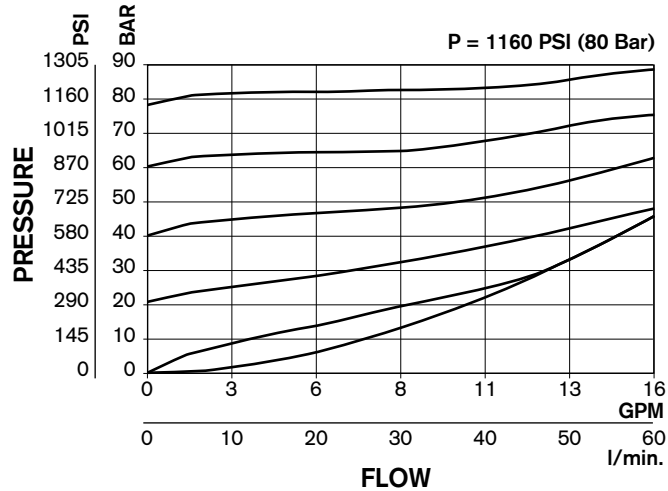

Dimensions - Inches (mm)

1.1

- ⊕ 9 810 161 176
- ⊕ 9 810 161 177
- ⊕ 9 810 161 178

1.3

- ⊕ 9 810 161 184
- ⊕ 9 810 161 185
- ⊕ 9 810 161 186

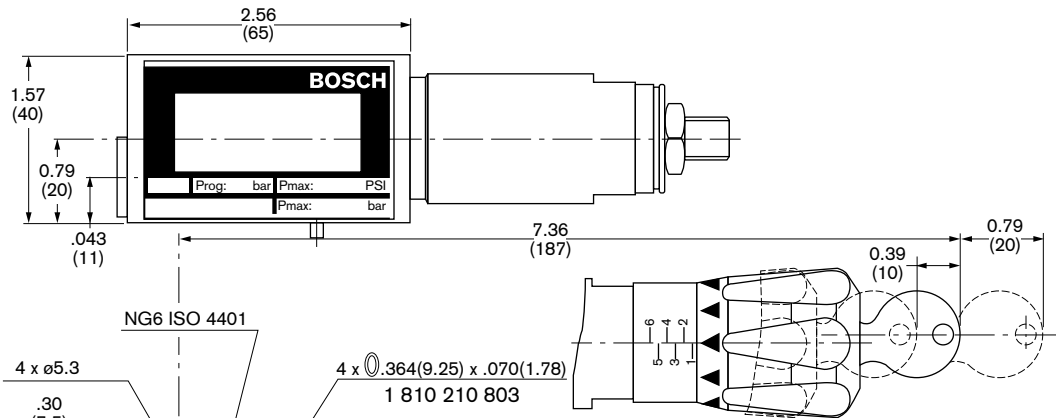



1.2

- ⊕ 9 810 161 175

1.4

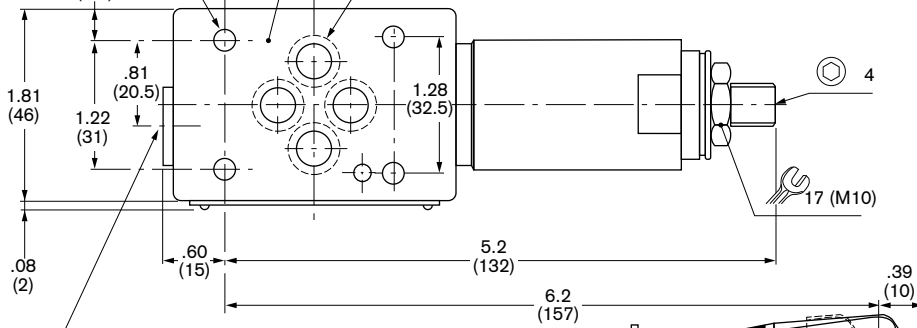
- ⊕ 9 810 161 183



⊕ 3/16:7/16-20UNF-2B 
(function P/T)

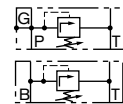



Dimensions - Inches (mm)

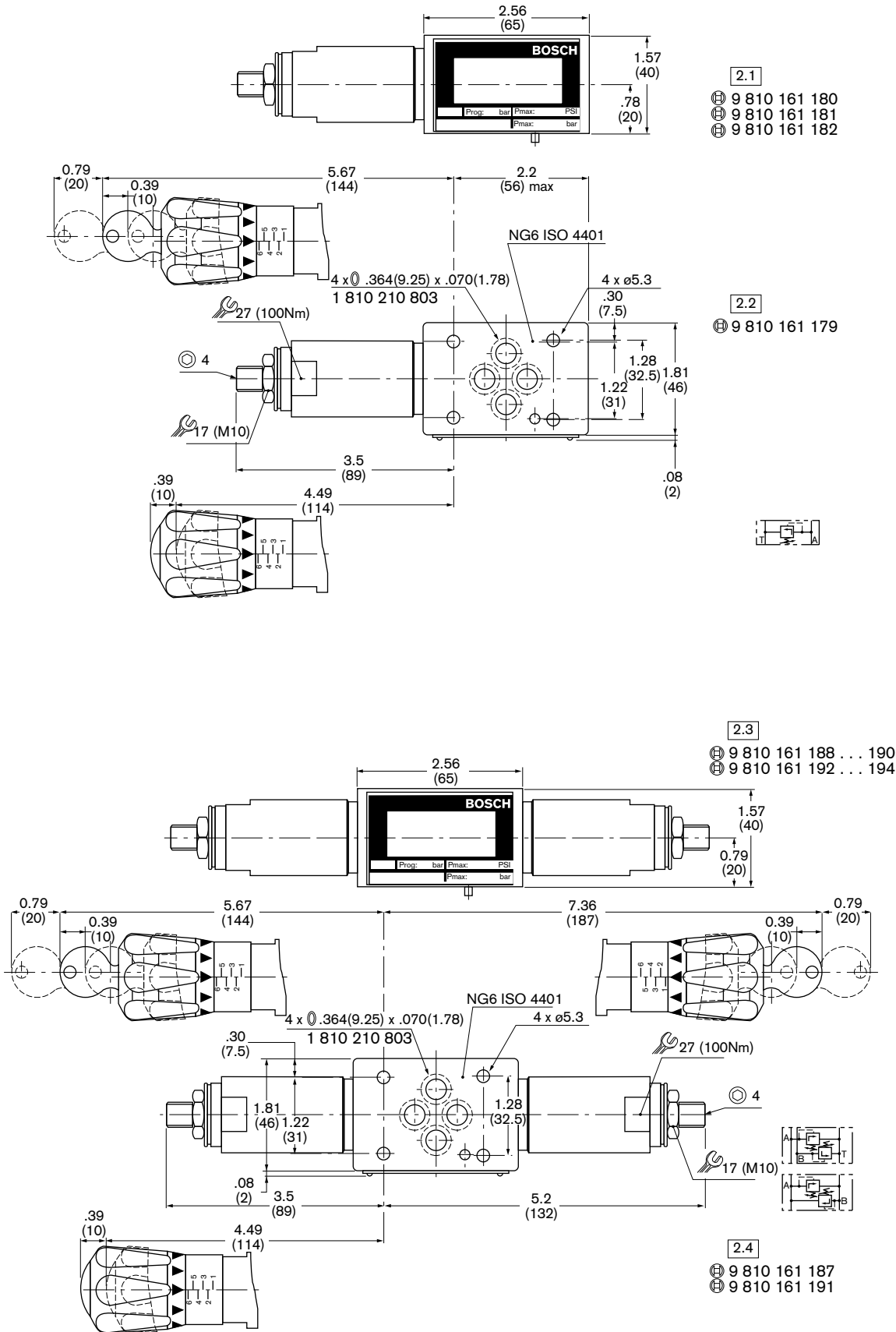

How to order				
TYPE	ORDER NO.	PRES. RANGE (psi)		*REF. CODE
		MIN>	MAX.	
P to T	LOCKING			
	9 810 161 175	70	1160	FE1 - SBAD MO1 S-50/LOCK
	9 810 161 176	70	1160	FE1 - SBAD MO1 S-50
	9 810 161 177	70	2300	FE1 - SBAE MO1 S-50
	9 810 161 178	70	4600	FE1 - SBDH MO1 S-50
A to T	LOCKING			
	9 810 161 179	70		FE1 - SBAD MO1 A-50/LOCK
	9 810 161 180	70	1160	FE1 - SBAD MO1 A-50
	9 810 161 181	70	2300	FE1 - SBAE MO1 A-50
	9 810 161 182	70	4600	FE1 - SBDH MO1 A-50
B to T	LOCKING			
	9 810 161 183	70		FE1 - SBAD MO1 B-50/LOCK
	9 810 161 184	70	1160	FE1 - SBAD MO1 B-50
	9 810 161 185	70	2300	FE1 - SBAE MO1 B-50
	9 810 161 186	70	4600	FE1 - SBDH MO1 B-50
A and B to T	LOCKING			
	9 810 161 187	70		
	9 810 161 188	70	1160	
	9 810 161 189	70	2300	
	9 810 161 190	70	4600	
CROSS PORT	LOCKING			
	9 810 161 191	70	1160	FE1 - SBAD MO1 AB-40/LOCK
	9 810 161 192	70	1160	FE1 - SBAD MO1 AB-40
	9 810 161 193	70	2300	FE1 - SBAE MO1 AB-40
	9 810 161 194	70	4600	FE1 - SBDH MO1 AB-40
			PSI BAR 1160 80 2300 160 4600 315	
			PSI BAR 70 5	

* **NOTE:** Codes are for **Reference Only**, use order number when ordering. The values of pressures in the Ref. Codes are approximate, please refer to Pressure Range Section for exact pressures.

**Pressure relief valves
pilot operated**

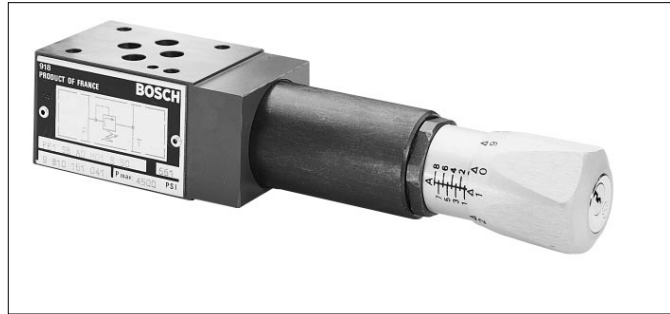

Function

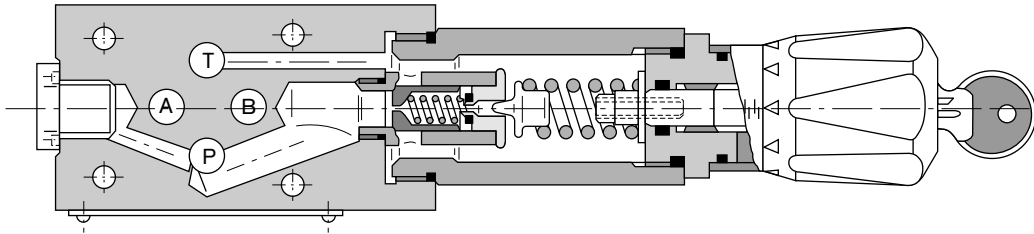

Symbol	Adjustment	P. nom. PSI (bar)	Dimensions	Lbs. (kg)	(H)
		60-1160 (4 ... 80)	3.1	3 (1.4)	9 810 161 063
		300-2300 (20 ... 160)			9 810 161 064
		60-1160 (4 ... 80)	3.2		9 810 161 061
		300-2300 (20 ... 160)			9 810 161 062

Specifications	
Valve function	Pressure relief valve, pilot operated
Mounting type	Intermediate plate D03 (NG 6, ISO 4401)
Mounting position	Optional
Fluid	Petroleum, fire resistant, HWCF
Viscosity	60 ... 2300 SUS (10 - 500cSt)
Fluid-temperature	-10 ... 130°F (-23 to 54°C) (max 160° F)
Filtration	Contamination class 10: according to NAS 1638 ISO/DIS 4406, class 19116 can be realized with filter $\beta_{25} = 75^*$
Seals	Fluorocarbon (Viton®)
Max. setting pressure	1160, 2300 PSI
Max. input pressure	4600 PSI (315 bar)
Max. flow	13.2 gpm (50 l/min.)

PRODUCT LITERATURE DISCLAIMER
 SPECIFICATIONS AND/OR
 DIMENSIONS ARE SUBJECT TO
 CHANGE WITHOUT PRIOR NOTICE.
 PLEASE CONSULT FACTORY.

* Dirt particles retention rate > 25 µm is 1 = 75, ie. 98.6%.

Performance curves
 $v = 35\text{mm}^2/\text{s}$, $P = 250\text{ bar}$

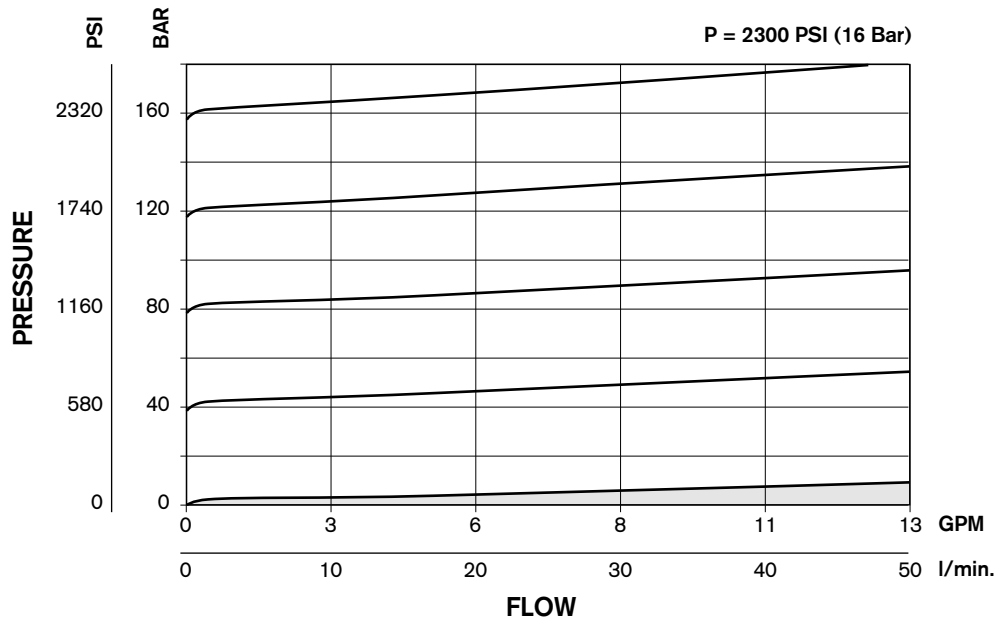
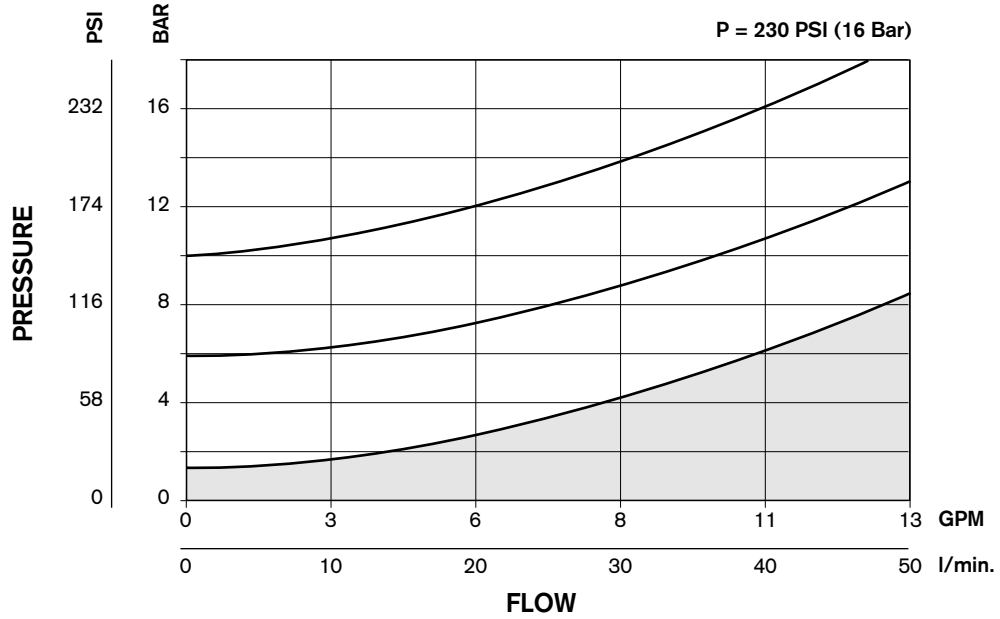



Dimensions - Inches (mm)

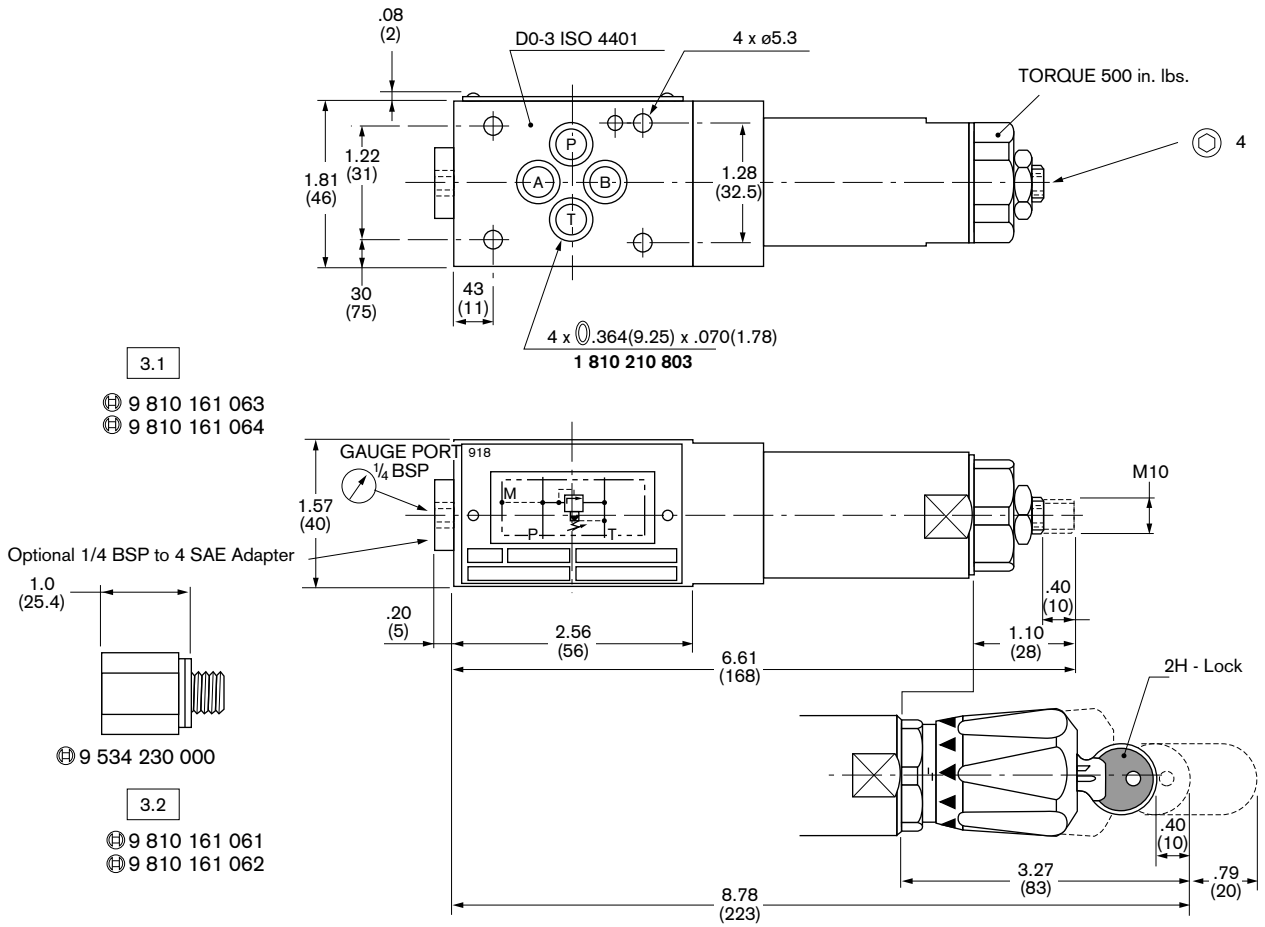

How to order				
TYPE	ORDER NO.	PRES. RANGE (psi)		*REF. CODE
		MIN>	MAX.	
P to T	LOCKING			
	9 810 161 061	30	1160	FE1 - PBAD MO1 S-50/LOCK
	9 810 161 062	30	2300	FE1 - PBAE MO1 S-50/LOCK
	9 810 161 063	30	1160	FE1 - PBAD MO1 S-50
	9 810 161 064	30	2300	FE1 - PBAE MO1 S-50
			PSI	BAR
			1160	80
			2300	160
			PSI	BAR
			30	2







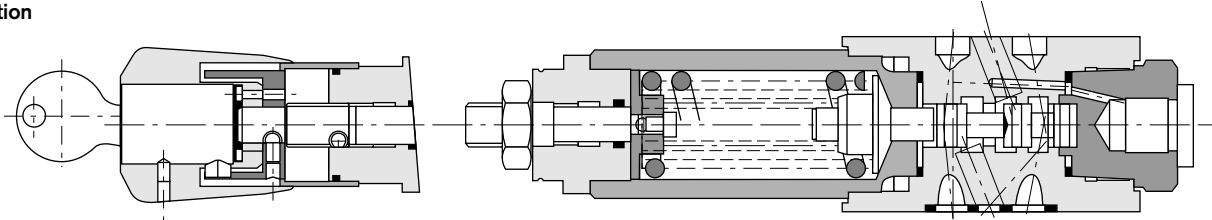

* NOTE: Codes are for Reference Only, use order number when ordering. The values of pressures in the Ref. Codes are approximate, please refer to Pressure Range Section for exact pressures.

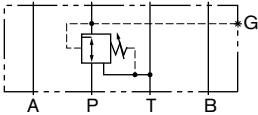
**Pressure reducing valves
direct operated**

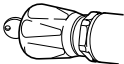
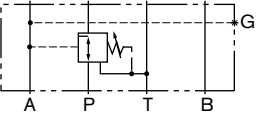

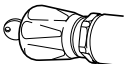
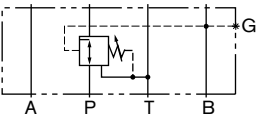
Function

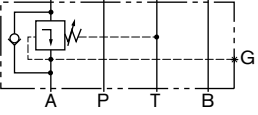

Symbol	Adjustment	P. nom. PSI (bar)	Dimensions	Lbs. (kg)	
		45-430 (3 ... 30)	6.1	3.3 (1.5)	9 810 161 153
		60-1160 (4 ... 80)			9 810 161 154
		300-2300 (20 ... 160)			9 810 161 155
		300-3600 (20 ... 250)			9 810 161 156
		45-430 (3 ... 30)	6.2		9 810 161 151
		60-1160 (4 ... 80)	6.2		9 810 161 152
		45-430 (3 ... 30)	6.1	9 810 161 157	
		60-1160 (4 ... 80)		9 810 161 158	
		300-2300 (20 ... 160)		9 810 161 159	
		300-3600 (20 ... 250)		9 810 161 160	
		45-430 (3 ... 30)	6.2	On request	
		60-1160 (4 ... 80)	6.2	On request	
		45-430 (3 ... 30)	6.1	9 810 161 161	
		60-1160 (4 ... 80)		9 810 161 162	
		300-2300 (20 ... 160)		9 810 161 163	
		300-3600 (20 ... 250)		9 810 161 164	
		45-430 (3 ... 30)	6.2	On request	
		60-1160 (4 ... 80)	6.2	On request	
		60-1160 (4 ... 80)	6.1	9 810 161 165	
		300-2300 (20 ... 160)		9 810 161 166	
		60-1160 (4 ... 80)	6.2	On request	

Pressure reducing valves direct operated

Specifications		
Valve function	Pressure reducing valve, direct operated	
Mounting type	Intermediate plate NG 6, ISO 4401	
Mounting position	Optional	
Fluid	Petroleum, fire resistant, HWCF	
Viscosity	60 . . . 2300 SUS (10 - 500cSt)	
Fluid-temperature	-4 . . . 175°F (-20 to 80°C)	
Filtration	Contamination class 10: according to NAS 1638 ISO/DIS 4406, class 19116 can be realized with filter $\beta_{25} = 75^*$	
Seals	Fluorocarbon (Viton®)	
Max. setting pressure	435,1160 bar	2360, 3625 bar
Max. input pressure	3045 PSI (210 bar)	4600 PSI (315 bar)
Max. flow	15.8 gpm (60 l/min.)	

PRODUCT LITERATURE DISCLAIMER
 SPECIFICATIONS AND/OR DIMENSIONS ARE SUBJECT TO CHANGE WITHOUT PRIOR NOTICE. PLEASE CONSULT FACTORY.

* Dirt particles retention rate > 25 µm is 1 = 75, ie. 98.6%.

Performance curves
 $v = 35\text{mm}^2/\text{s}$, $P = 250\text{ bar}$

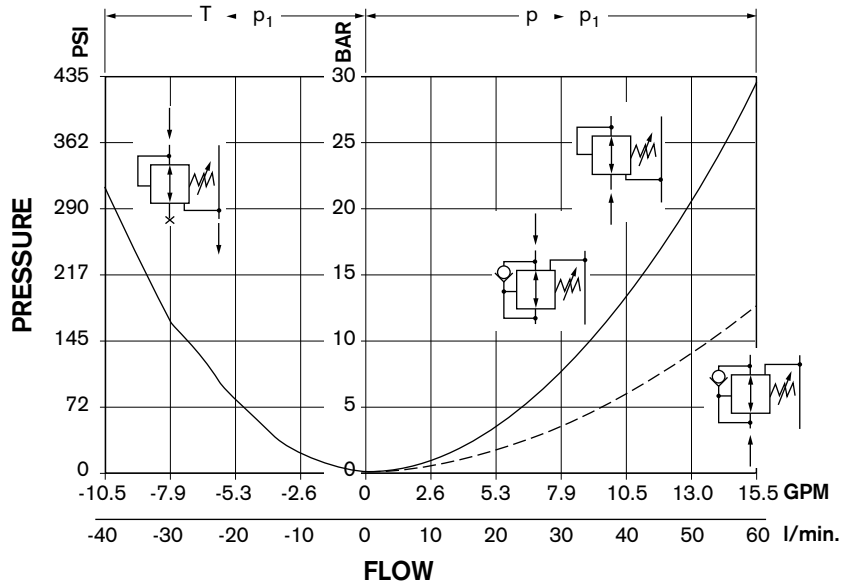
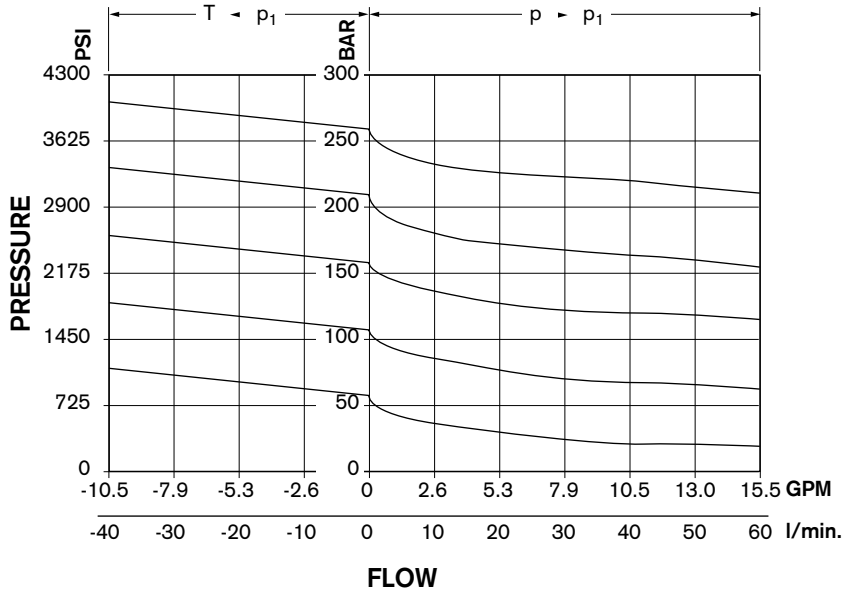

**Flow control
throttle check valves**



Function

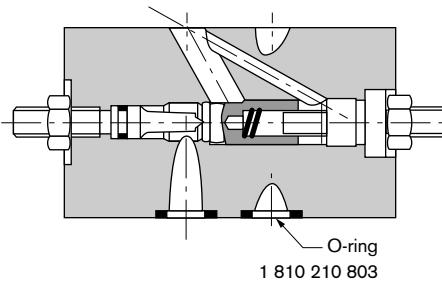
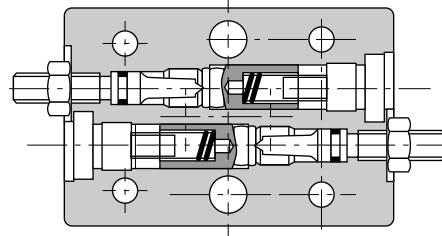

Symbol	Throttle for	Adjustment	Dimensions	P _{max.} PSI (bar)	Lbs. (kg)	Ⓜ
	meter-out		5.1	4600 (315)	3.3 (1.5)	9 810 161 168
	meter-in		5.1			9 810 161 167

Flow control throttle check valves

Specifications	
Valve function	Throttle check valve
Mounting type	Intermediate plate NG 6, ISO 4401
Mounting position	Optional
Fluid	Petroleum, fire resistant, HWCF
Viscosity	60 . . . 2300 SUS (10...50CST)
Fluid-temperature	-4 . . . 175°F (-20 to 80°C)
Filtration	Contamination class 10 according NAS 1638 can be realized with filter $\beta_{25} = 75^*$
Seals	Fluorocarbon (Viton®)
Max. operating pressure	4600 PSI (315 bar)
Max. flow	15.8 gpm (60 l/min)

PRODUCT LITERATURE DISCLAIMER
 SPECIFICATIONS AND/OR DIMENSIONS ARE SUBJECT TO CHANGE WITHOUT PRIOR NOTICE. PLEASE CONSULT FACTORY.

* Dirt particles retention rate > 25 µm is 1 = 75, ie. 98.6%.

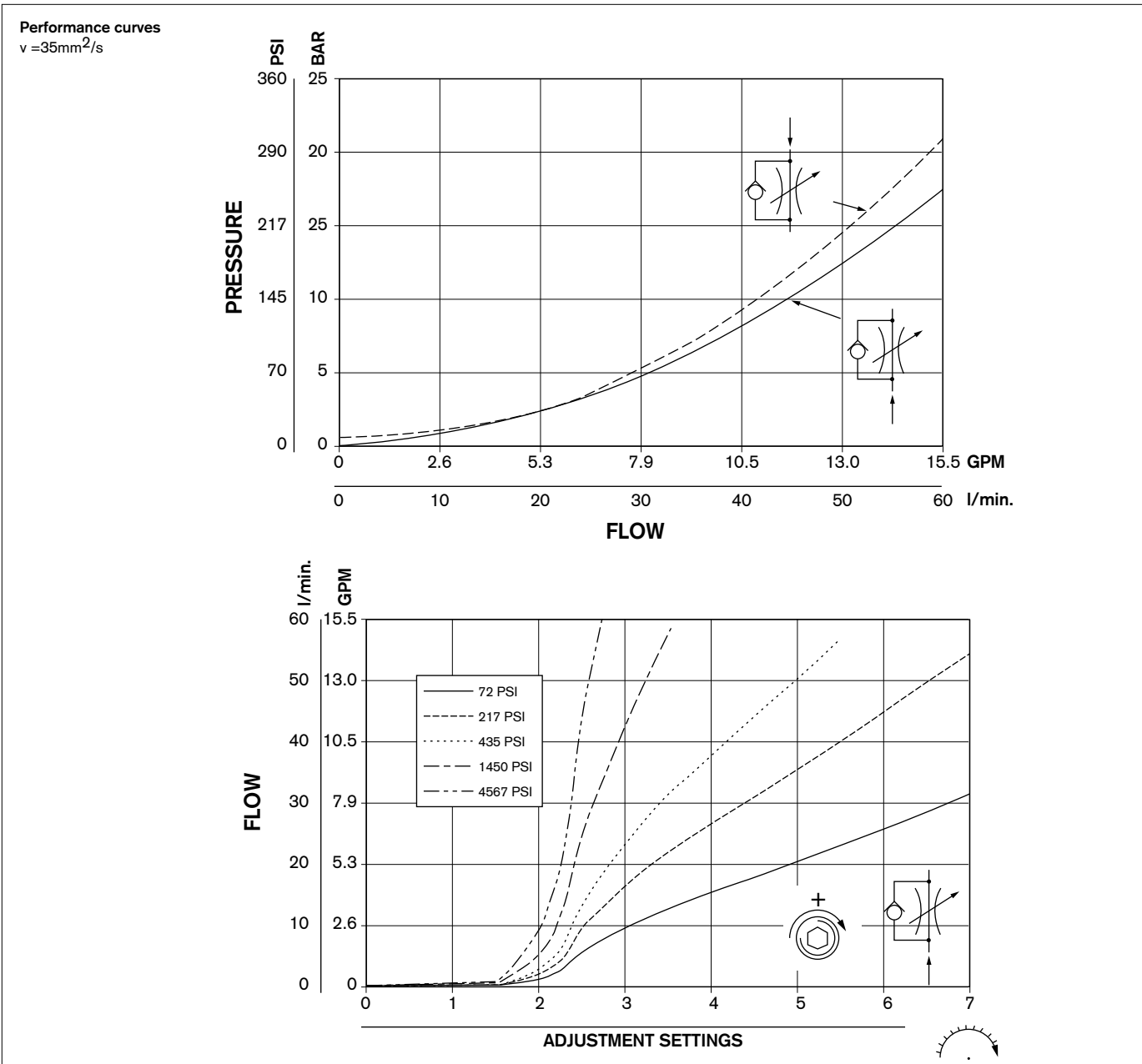

Flow control throttle check valves

Dimensions - Inches (mm)

5.1

- 9 810 161 167
- 9 810 161 168

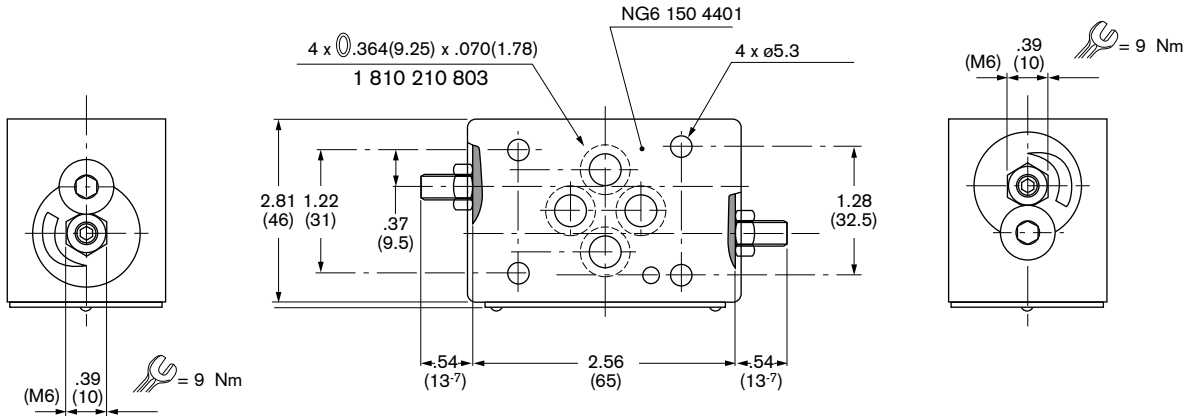
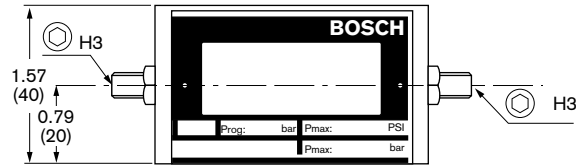

**Throttle valves
throttle check valves**

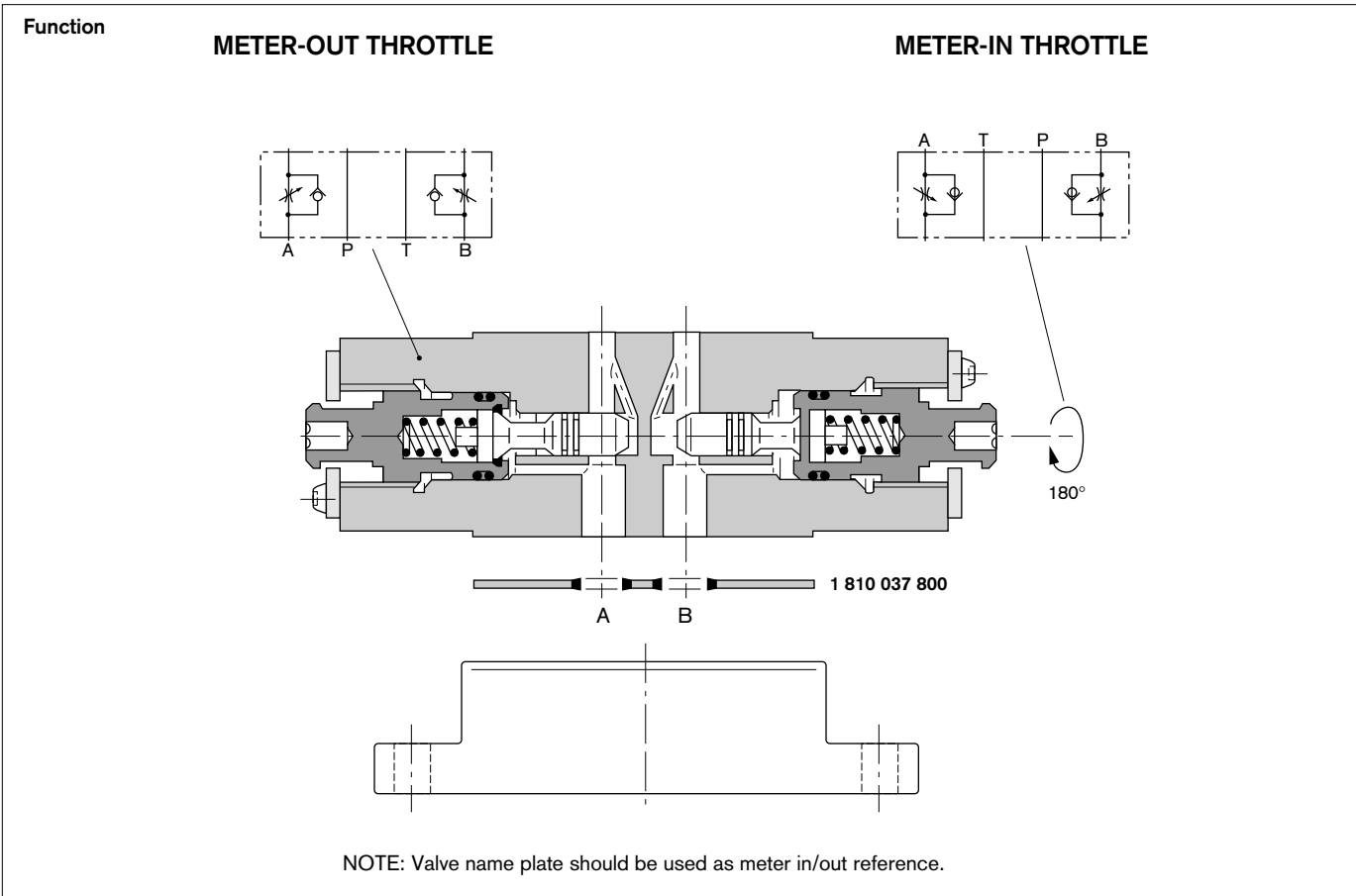
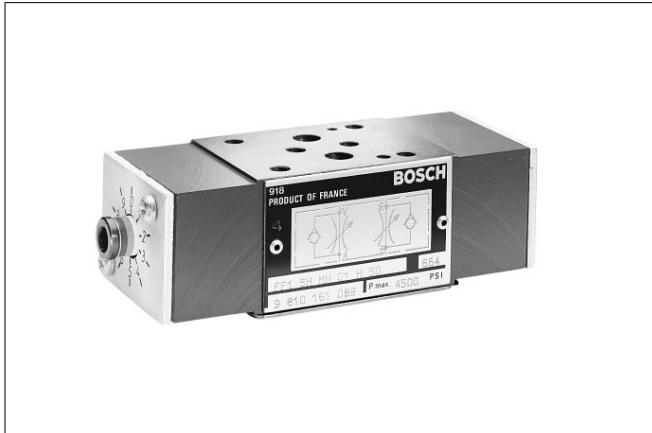

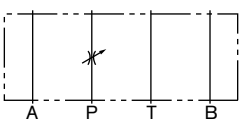
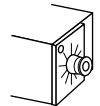
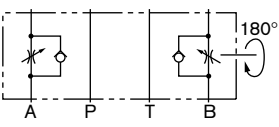
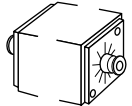
Symbol	Throttle for	Adjustment	Dimensions	P _{max.} PSI	Lbs. (kg)	
	meter-in		4	4600 PSI (315 bar)	2.2 (1.0)	9 810 161 088
	meter-in/out (interchangeable)		5			

Throttle valves throttle check valves

Specifications	
Valve function	Flow control
Mounting type	Intermediate plate DO3 (NG 6 ISO 4401)
Mounting position	Optional
Fluid	Petroleum, fire resistant, HWFC
Viscosity	60 . . . 2300 SUS (10 - 100 cSt)
Fluid-temperature	-4 . . . 175°F (-20 to 80°C)
Filtration	Contamination class 10, according to NAS 1638 can be realized with filter $\beta_{25} = 75^*$
Seals	Fluorocarbon (Viton®)
Max. operating pressure	4600 PSI (315 bar)
Min. flow	.05 GPM (.23 l/min.)
Max. flow	13.2 GPM (50 l/min.)

PRODUCT LITERATURE DISCLAIMER
 SPECIFICATIONS AND/OR DIMENSIONS ARE SUBJECT TO CHANGE WITHOUT PRIOR NOTICE. PLEASE CONSULT FACTORY.

* Dirt particles retention rate > 25 µm is 1 = 75, ie. 98.6%.

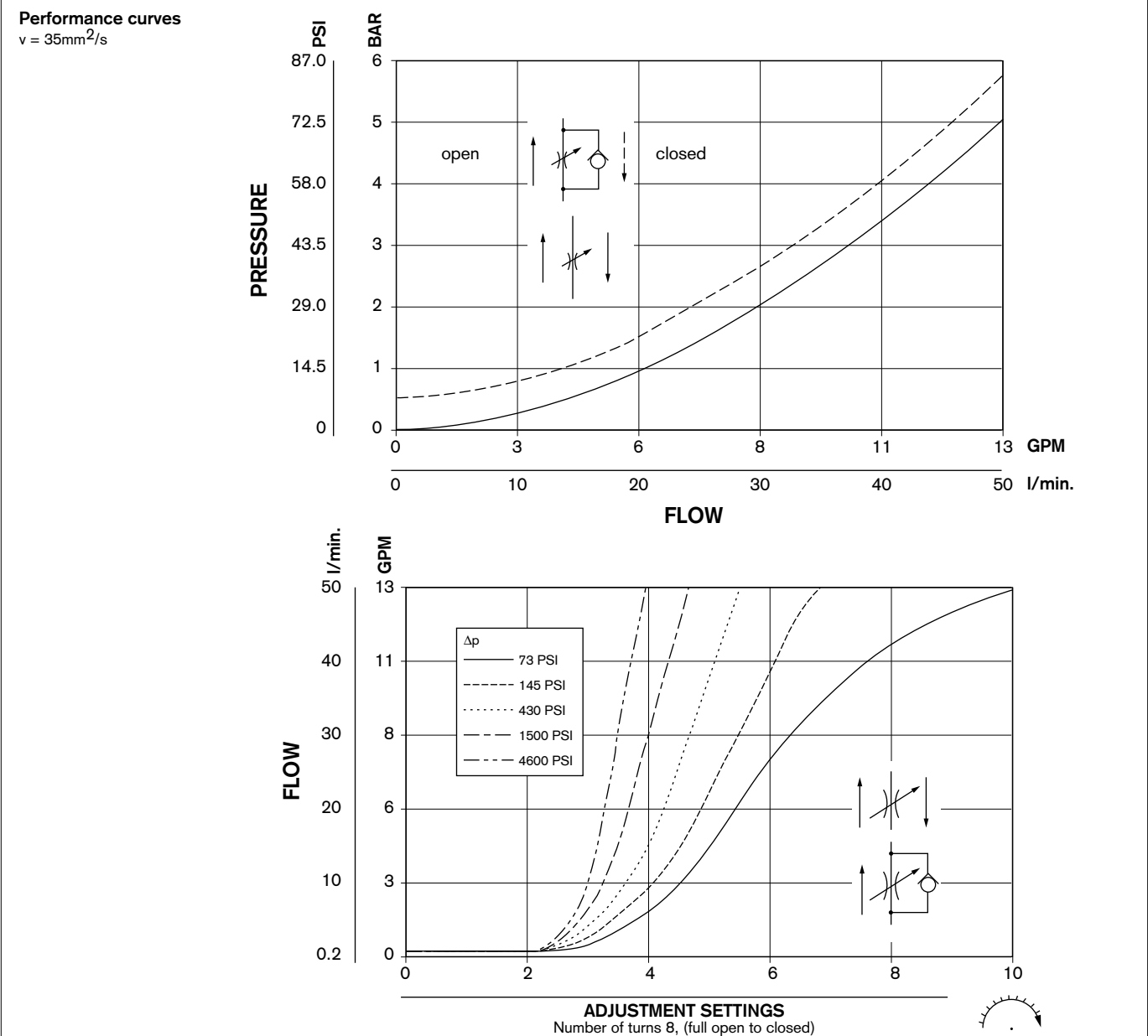

Throttle valves throttle check valves

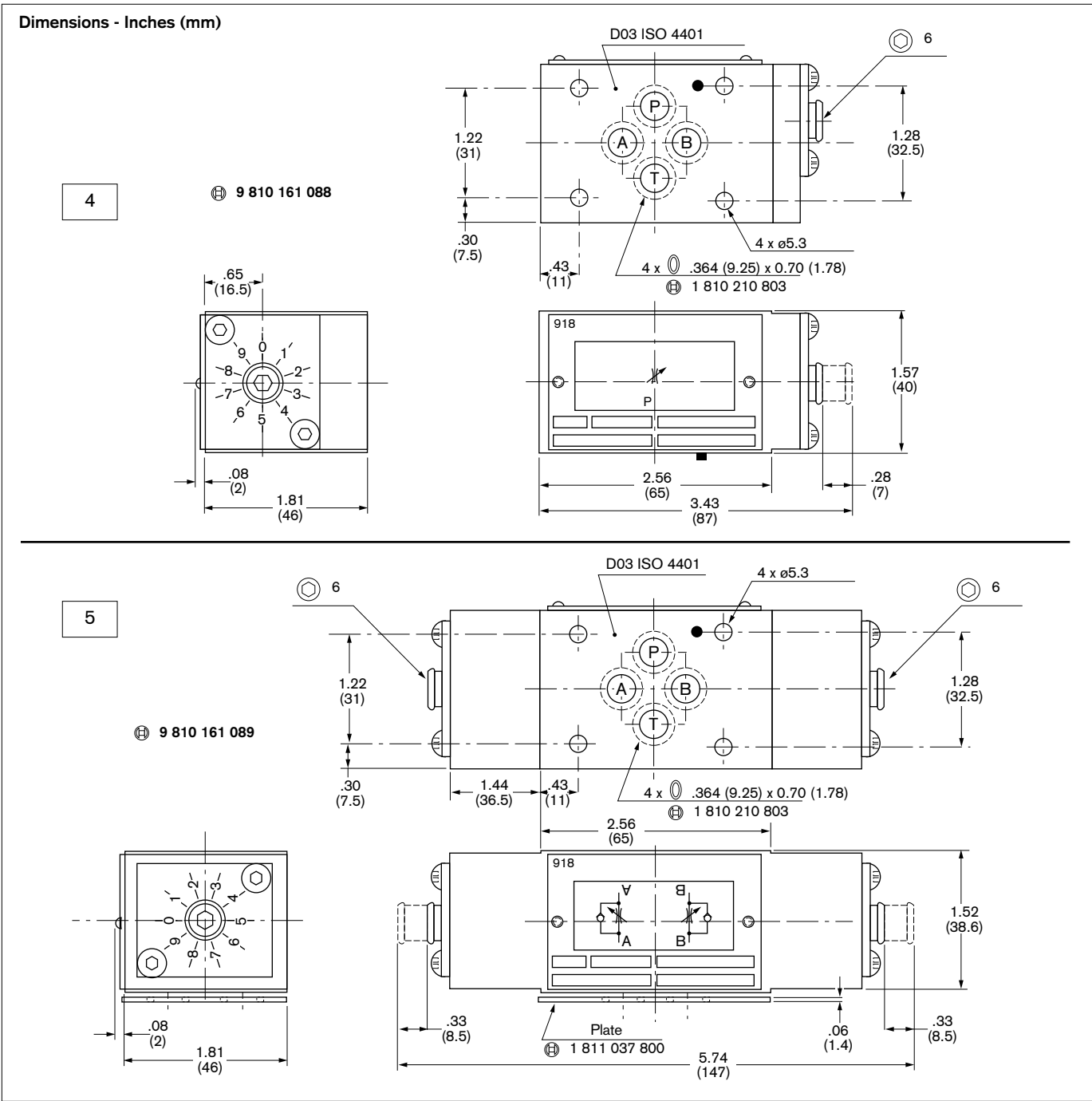

How to order

Type	Order Number	Pressure Range (psi)	*Ref. Code
P PORT METER	9 810 161 088	Max. 4600	
A and B PORT METER	9 810 161 089	4600	FF1 - SHMH—01 H-50
		PSI 4600	BAR 315

*NOTE: Codes are for Reference Only, use order number when ordering. The values of pressures in the Ref. Code are approximate, please refer to Pressure Range for exact pressures.

Check Valves



Function

9 810 161 173
9 810 161 174

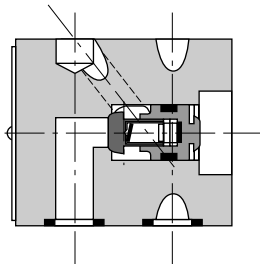

9 810 161 169
9 810 161 170
9 810 161 171

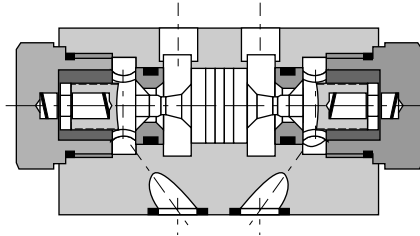

Symbol	Opening Pressure PSI (bar)	Dimensions	P. max PSI (bar)	Lbs. (kg)	Ⓜ	
	8 (0.5)	7	4600 (315)	2.0 (0.9)	9 810 161 173	
	22 (1.5)	7				9 810 161 174
	Pilot ratio A ₁ :A ₂ 3.5 : 1*	8	4600 (315)	2.86 (1.3)	9 810 161 169	
	3.5 : 1*	8				9 810 161 170
	3.5 : 1*	8				9 810 161 171

* Direct operated

Check Valves

Specifications	
Valve function	Check valve or pilot operated check valve
Mounting type	Intermediate plate NG 6, ISO 4401
Mounting position	Optional
Fluid	Petroleum, fire resistant, HWFC
Viscosity	60 . . . 2300 SUS (10 . . . 500 cSt)
Fluid-temperature	-4 . . . 175°F (-20 to 80°C)
Filtration	Contamination class 10 according to NAS 1638 can be realized with filter $\beta_{25} = 75^*$
Seals	Fluorocarbon (Viton®)
Max. operating pressure	4600 PSI (315 Bar)
Max. flow	15.8 GPM (60 l/min.)

PRODUCT LITERATURE DISCLAIMER
 SPECIFICATIONS AND/OR DIMENSIONS ARE SUBJECT TO CHANGE WITHOUT PRIOR NOTICE. PLEASE CONSULT FACTORY.

* Dirt particles retention rate > 25 µm is 1 = 75, ie. 98.6%.

Performance curves
 $v = 35\text{mm}^2/\text{s}$

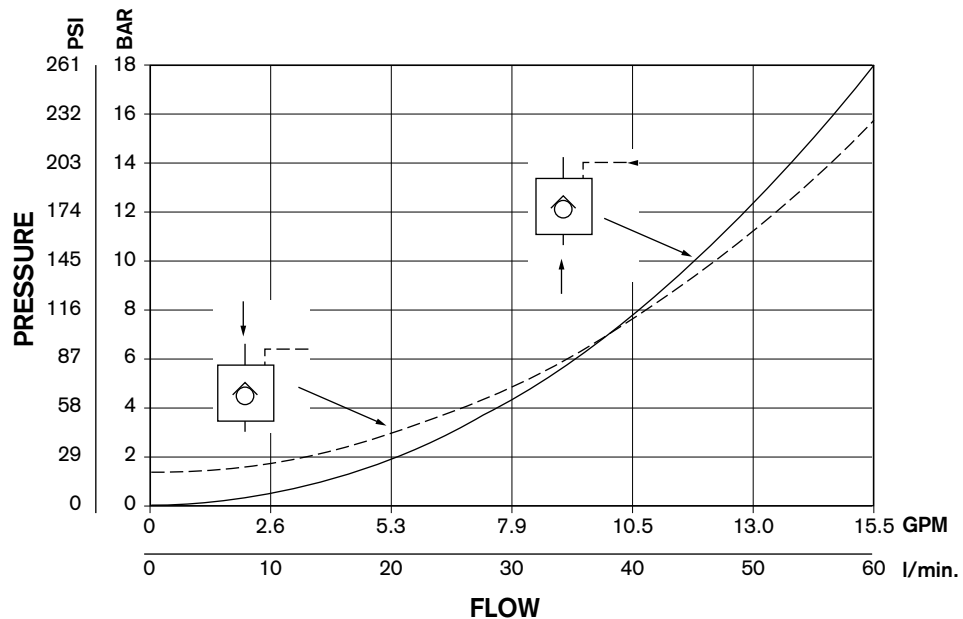
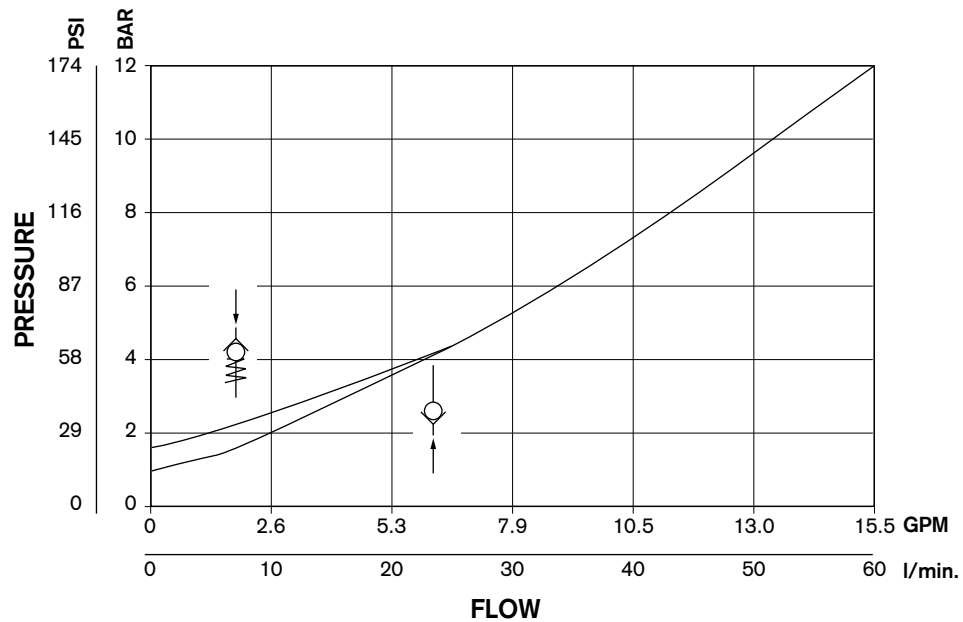

Check Valves

Dimensions - Inches (mm)

7

- ⊕ 9 810 161 073
- ⊕ 9 810 161 074

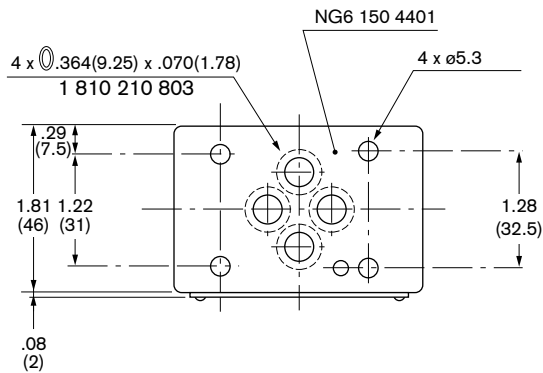
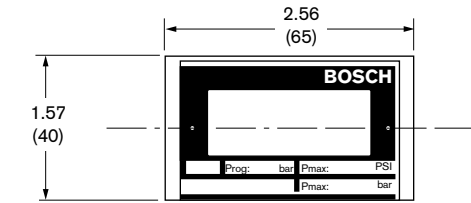

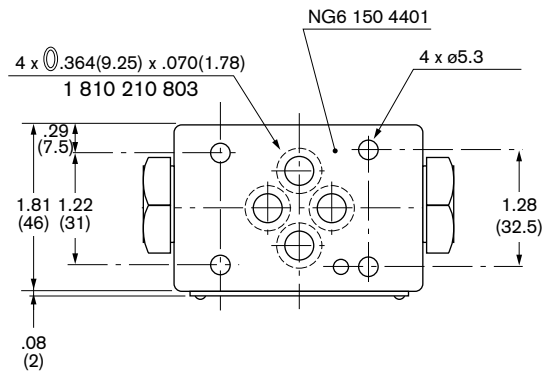
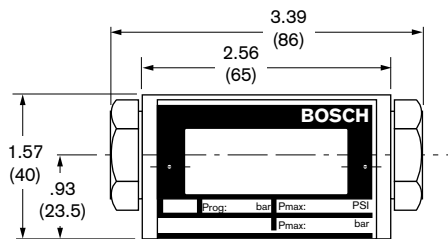

8

- ⊕ 9 810 161 169
- ⊕ 9 810 161 170
- ⊕ 9 810 161 171

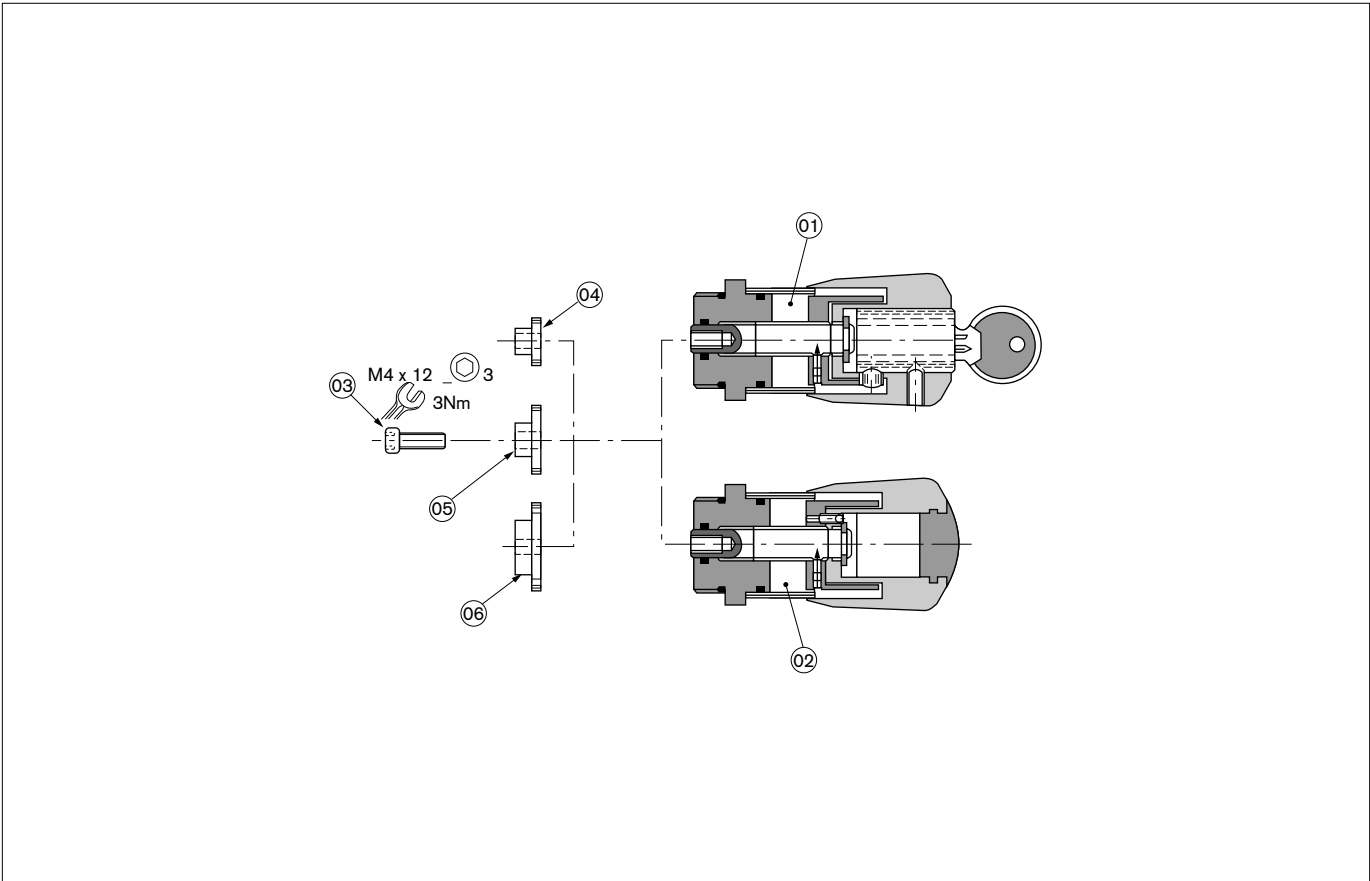

Control knob



		Kit	
Valve		Parts	
9 810 161 151 . . . 166	Pressure reducing valve	1 x 01 + 1 x 03 1 x 06	1 817 001 803
		1 x 02 + 1 x 03 1 x 06	1 817 001 808

NG6, D03 (D01) Bolt Kits

**TABLE 1
D03 VALVE & SUBPLATE DIMENSIONS FOR BOLTS**

VALVE	A	B MINIMUM*	A + B
Racine/Bosch	0.87 (22)	.285 (7.2)	1.155 (29)
Racine	0.94 (23.9)	.285 (7.2)	1.23 (31.1)

*NOTE: Minimum depth of fastener is based on 1 1/2 times bolt diameter for ferrous subplates or manifolds.

Determining Bolt Length

To find the required length socket head cap screw when using a Racine/Bosch or Racine NG6, D03 (D01) 4-way valve and Racine/Bosch modules, use dimension A + B (Table 1) plus the total height of all modules used (Table 2).

RECOMMENDED BOLT KITS

No. Modules	Racine/Bosch	Racine
Valve only	B-227	B-120
Valve + 1 module	B-215	B-218
Valve + 2 module	B-216	B-216
Valve + 3 module	B-217	B-219

LENGTH RACINE/BOSCH VALVE & MODULE L = 1.15" and combined height of all modules
LENGTH RACINE VALVE, RACINE/BOSCH VALVE & MODULE L = 1.23" and combined height of all modules

EXAMPLE: Determining the proper length bolt to mount a check valve module with a NG6 Racine Racine/Bosch 4-way valve.

HEIGHT = 1.155" + 1.57" = 2.725" (A + B + D)

Use bolt kit B-215.

TORQUE
10-24 Threads = 50 in. lbs..

AVAILABLE BOLT KITS**

Length in Inches	Kit #
1-1/8	B-227
1-1/4	B-120
2-3/4	B-215
2-7/8	B-218
4-3/8	B-216
5-15/16	B-217
6	B-219

** Consist of four 10-24 socket head cap screws.

**TABLE 2
NG6 MODULE HEIGHT**

MODULE	PART NUMBER	(D) HEIGHT
Flow	9 810 161 . . .	1.57 (40)
	9 810 161 . . .	
Check	9 810 161 . . .	1.57 (40)
Pressure Reducing	9 810 161 . . .	1.57 (40)
Pressure Relief	9 810 161 . . .	1.57 (40)

*NOTE: Minimum Thread Engagement into manifold or subplate is .375".

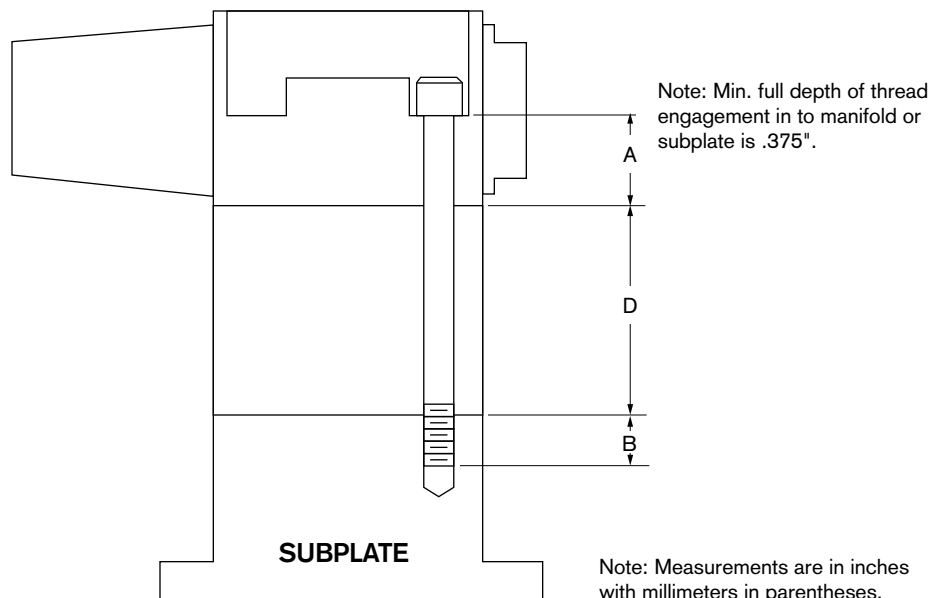

Note: Measurements are in inches with millimeters in parentheses.

NG6, D03 (D01) Studs

TABLE 1
D03 VALVE & SUBPLATE DIMENSIONS FOR BOLTS

VALVE	A	B MINIMUM*	C MIN/MAX	A + B + C**
Racine/Bosch	0.87 (22)	.285 (7.2)	0.29 (7.4)/0.38 (8.7)	1.46 (36)
Racine	0.94 (23.9)	.285 (7.2)	0.29 (7.4)/0.38 (8.7)	1.52 (38.5)

*NOTE: Minimum depth of fastener is based on 1 1/2 times bolt diameter for ferrous subplates or manifolds.
**Length determined using minimum dimension for C.

Determining Stud Length

To find the required stud length when using a Racine/Bosch or Racine NG6, D03 (D01) valve and Racine/Bosch modules, use dimension A + B + C (Table 1) plus the total height of all modules used (Table 2).

RECOMMENDED STUD KITS

No. Modules	Racine/Bosch	Racine
Valve + 2 module	B-234	B-236
Valve + 3 module	B-235	B-235

To make your own stud kits, threaded rod is available in three foot lengths (Grade 7) and can be cut to the desired length with a hack saw.

- B-156 10 each** 10-24 threaded rod 36 inches (911.1) long
- 50 each** 10-24 stud nut

TORQUE

10-24 Threads = 50 in. lbs..

AVAILABLE STUD KITS***

Length in Inches	Kit #
4-5/8	B-234
4-3/4	B-236
6-1/4	B-235

*** Consist of four 10-24 socket head cap screws.

TABLE 2
NG6 MODULE HEIGHT

MODULE	PART NUMBER	(D) HEIGHT
Flow	9 810 161 ...	1.57 (40)
	9 810 161 ...	
Check	9 810 161 ...	1.57 (40)
Pressure Reducing	9 810 161 ...	1.57 (40)
Pressure Relief	9 810 161 ...	1.57 (40)

*NOTE: Minimum Thread Engagement into manifold or subplate is .375".

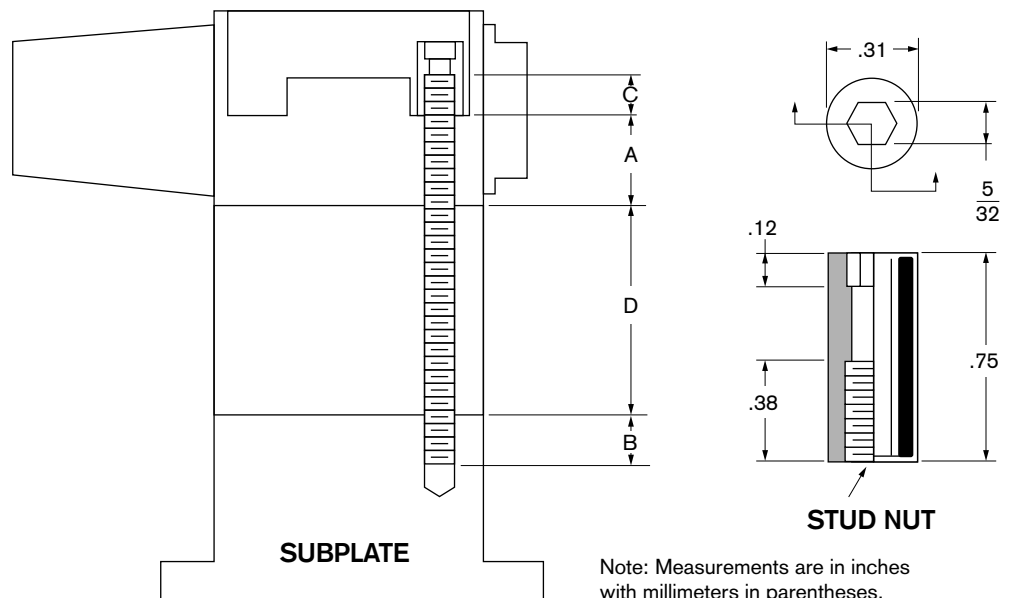

Note: Measurements are in inches with millimeters in parentheses.

Mounting information

With modular valves, circuits are easily built by stacking them between the directional control valve and the subplate. No piping is required which saves and reduces the time and work required to build the circuit. This saves money and there are no connections to leak. The circuit can be easily changed by adding or removing modules as needed.

When several modular valves are used together, how they are stacked can affect their performance. Some general rules are listed below. The valves can be broken down into two groups; those that function in the pressure line and those that function in the actuator lines (refer to drawing).

FUNCTION IN PRESSURE LINE

- Relief
 - Reducing/Relieving
1. Relief valve should be installed next to the subplate.
 2. Reducing/relieving valve should be placed between the relief and directional control valve.

FUNCTION IN ACTUATOR LINES

- Flow
 - P.O. Check
1. When using a P.O. check module with a meter out flow control module, the P.O. check should be closer to the directional control valve.

MOUNTING BOLTS — If the mounting bolts are customer supplied, only SAE grade 8 bolts should be used. Minimum recommended thread engagement is; 1.5 x diameter for cast iron and steel and 2 x diameter for aluminum.

Refer to Catalog number 9 535 233 717 – Directional Control Valves NG6...NG32, D03...D10 for information on the 1/8" (D03) 4-Way Valve.

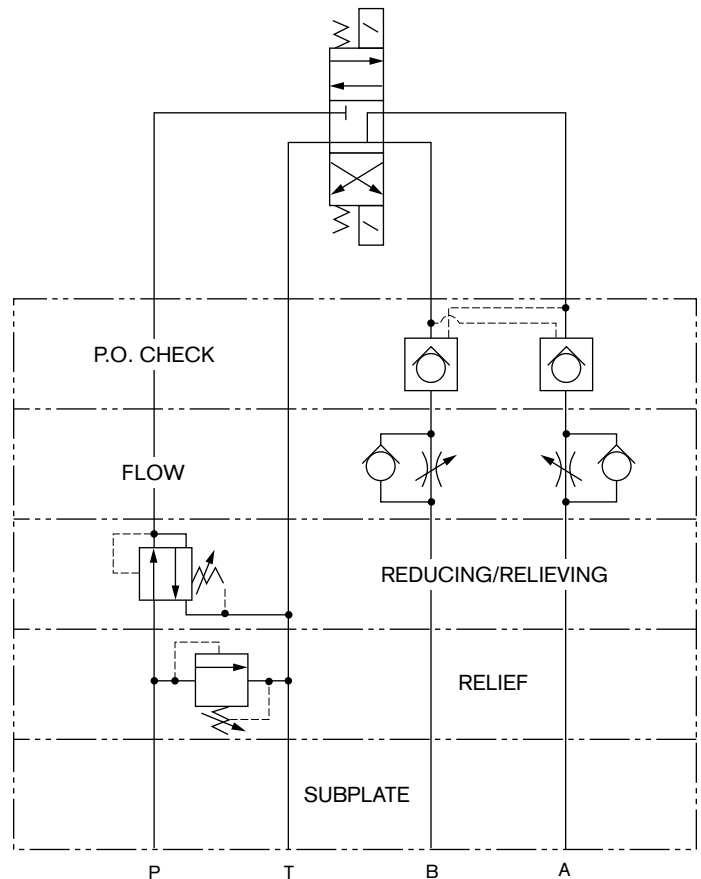

9 535 233 167
ATUS AKY 010/1 (1/97)

ROBERT BOSCH FLUID POWER CORPORATION
P.O. BOX 2025
RACINE, WISCONSIN 53401-2025 U.S.A.
Phone (414)554-7100, Fax (414)554-7117



BOSCH