

rexroth

A Bosch Company

Operating instructions

Pressure transducer for hydraulic applications

Type HM20-2x



DNV
DNV.COM/AF



Content

1	About this documentation	3
1.1	Validity of the documentation	3
1.2	Required and supplementary documentation	4
1.3	Representation of information	4
1.4	About this chapter	6
1.5	Intended use	6
1.6	Improper use	6
1.7	General safety instructions	7
1.8	Product- and technology-related safety instructions	8
2	General notes on damage to property and damage to the product	11
3	Scope of delivery	11
4	Product description	11
5	Transport and storage	13
6	Installation	14
7	Electrical connection	14
8	Dimensional drawing	15
9	Commissioning and operation	16
10	Maintenance and repair	17
11	Demounting and replacement	17
12	Disposal and environmental protection	18
13	Technical data	18
14	List of addresses	20

The data specified only serve to describe the product. If information on the use of the product is given, it is only to be regarded as application examples and recommendations.

Catalog specifications do not constitute assured characteristics. The information given does not release the user from the obligation of own judgment and verification. It must be remembered that our products are subject to a natural process of wear and aging.

© This document, as well as the data, specifications and other information set forth in it, are the exclusive property of Bosch Rexroth AG.

It may not be reproduced or given to third parties without its consent.

The cover shows an example configuration. The product delivered may differ from the image on the cover.

Translation of the original operating instructions. The original operating instructions were prepared in German language.

1 About this documentation

1.1 VALIDITY OF THE DOCUMENTATION

This documentation is valid for pressure transducer HM20-2x. It is intended for fitters, operators, service technicians, system operators and plant/machine manufacturers.

This documentation contains important information on the safe and appropriate installation, commissioning and use of the product.

- ▶ Read this documentation completely and particularly chapter 2 "Safety instructions" before working with the product.

1.2 REQUIRED AND SUPPLEMENTARY DOCUMENTATION

The present instructions are valid in conjunction with data sheet RE 30272.

1.3 REPRESENTATION OF INFORMATION

Safety instructions

In this documentation, safety instructions are provided whenever there is a risk of personal injury or damage to equipment. The hazard avoidance measures described must be observed. Safety instructions are structured as follows:



SIGNAL WORD



Type and source of danger!

Consequences in case of non-compliance

- ▶ Hazard avoidance measures
- ▶ <Enumeration>

- **Warning symbol:** draws attention to a hazard
- **Signal word:** identifies the degree of hazard
- **Type and source of danger:** Specifies the type and source of danger
- **Consequences:** describes the consequences in case of non-observance
- **Precaution:** specifies how the hazardous situation can be prevented

Table 1: Hazard classifications according to ANSI Z535.6-2011

Warning symbol, meaning	Signal word
	Indicates a hazardous situation which, if not avoided, will certainly result in death or serious injury.
	Indicates a hazardous situation which, if not avoided, could result in death or serious injury.
	Indicates a hazardous situation which, if not avoided, could result in minor or moderate injury.
<p>NOTICE</p>	Damage to property: The product or the environment could be damaged.

1.3.1 Symbols

Symbol	Meaning
	If this information is disregarded, the product cannot be used or operated in an optimum manner.
▶	Individual, independent action
1.	Numbered instruction: The numbers indicate that the actions must be carried out one after the other.

1.4 ABOUT THIS CHAPTER

The product has been manufactured according to the generally accepted codes of practice. However, there is still a risk of personal injury and damage to property if you do not observe this chapter and the safety instructions in this documentation.

- ▶ Read this documentation completely and thoroughly before working with the product.
- ▶ Keep this documentation in a location where it is accessible to all users at all times.
- ▶ Always include the required documentation when you pass the product on to third parties.

1.5 INTENDED USE

The product is an electronic component. You may use the product as follows:

- For acquiring the system pressure of hydraulic systems
- In the original condition, without damage
- Only in applications for which it is suitable without any restrictions
- Only within the pressure limits provided in the operating range
- Only in conjunction with media to which the wetted materials are sufficiently resistant

The product is intended exclusively for professional use and not for private usage.

1.6 IMPROPER USE

Any use other than described in the section “Intended use” is considered as improper and is therefore not permitted.

Bosch Rexroth AG does not assume any liability for damage caused by improper use. The user assumes all risks involved with improper use.

1.7 GENERAL SAFETY INSTRUCTIONS

- Observe the valid regulations on accident prevention and environmental protection.
- Observe the safety regulations and provisions of the country in which the product is used/applied.
- Exclusively use Rexroth products in technically perfect condition.
- Observe all notices on the product.
- Persons who install, commission, operate, demount or maintain Rexroth products must not consume any alcohol, drugs or pharmaceuticals that may affect their ability to respond.
- Only use accessory and spare parts approved by the manufacturer in order to rule out personnel hazards arising from unsuitable spare parts.
- Comply with the technical data and ambient conditions specified in the product documentation.
- If unsuitable products are installed or used in safety-relevant applications, unintended operational states can occur in these applications, which can cause personal injury and damage to property. Therefore, use the product only in safety-relevant applications, if this use is expressly specified and permitted in the documentation of the product.

- You may commission the product only when it has been established that the final product (for example, a machine or system), in which the Rexroth product is installed, complies with national regulations, safety regulations and standards relevant for the application.
- For the scope of validity of cULus: The device shall be supplied from an isolating transformer having a secondary Listed fuse rated either
 - a) max 5 amps for voltages 0~20 Vrms (0~28.3 Vp) or
 - b) 100/Vp for voltages of 20~30 Vrms (28.3~42.4 Vp)The device shall be connected only by using any Listed (CYJV/7) or R/C (CYJV2/8) cord in respect of Condition of Acceptability, having suitable ratings.
- For the scope of validity for marine applications (DNV-GL), additional surge protection is required. In line with IACS-Unified Requirements E10.

1.8 PRODUCT- AND TECHNOLOGY-RELATED SAFETY INSTRUCTIONS



WARNING

Lines and system parts under pressure, ejecting hydraulic fluid!

When working on hydraulic systems with stored energy, hydraulic components may still be under pressure even after the pressure supply was switched off.

**WARNING**

During installation and demounting, the pressure transducer or parts may be hurled around and cause personal injuries and/or damage to property. There is moreover the risk of serious injury caused by a powerful, ejecting hydraulic fluid jet.

- ▶ Before carrying out any work, ensure that the hydraulic system is depressurized and the electrical control de-energized.
- ▶ Never disconnect, open or cut pressurized lines!
- ▶ Completely depressurize machines and systems before working on hydraulic products.

Faulty fastening!

Improper mounting can cause the pressure transducer to loosen, which can lead to hydraulic fluid flowing out. The loosened pressure transducer can cause injuries and damage to property.

- ▶ Install the pressure switch thoroughly according to the mounting instructions by means of suitable mounting aids.
- ▶ Adhere to the specified tightening torques.

High electrical voltage by incorrect connection!

Danger to life, risk of injury due to electric shock.

- ▶ The device may exclusively be installed by a qualified electrician.
- ▶ Voltage supply according to EN 50178, SELV, PELV

**WARNING****Easily inflammable hydraulic fluid!**

In connection with fire or other sources of heat, leaking hydraulic fluid mist, which results from defective or incompletely mounted pressure switches and their connections, may lead to fire or explosions.

- ▶ Do not use hydraulic components in areas with open fire and only at a sufficient distance to sources of heat.

**CAUTION****Overpressure!**

Risk of injury and risk of destruction of the pressure sensor, even if the overload pressure is exceeded only briefly.

- ▶ Avoid steady-state and dynamic overpressures that exceed the specified nominal pressure.

High surface temperatures!

Caution when touching the pressure switch during operation. The surface temperature may exceed permissible temperatures according to DIN EN 563. This can result in burns.

- ▶ Let the pressure switch cool down before touching it or wear protective gloves.
- ▶ Protect the housing against contact with flammable substances and against accidental touching.

2 General notes on damage to property and damage to the product

NOTICE

Dirt and foreign particles in hydraulic components!

Penetrating dirt and foreign particles lead to wear and malfunctions. Safe functioning of the hydraulic components is no longer ensured.

- ▶ During installation, ensure utmost cleanliness in order to prevent foreign particles such as welding beads or metal chips from getting into the hydraulic lines.

3 Scope of delivery

- 1 x pressure transducer
- 1 x documentation in German and English

4 Product description

The pressure transducer senses the hydraulic pressure and translates it into an analog output signal.

4...20 mA (HM20-2x...C-K35-N)

0.1...10 V (HM20-2x...H-K35-N)

0.5...5 V (HM20-2x...F-C13-N)

Table 2: Type of pressure: Relative pressure

Type designation HM20-2x...	Interface	Transducers with connector/with cable
.../010-C-K35-N ¹⁾	4...20 mA	Connector M12
.../010-H-K35-N	0.1...10 V	
.../050-C-K35-N ¹⁾	4...20 mA	Connector M12
.../050-H-K35-N	0.1...10 V	
.../100-C-K35-N ¹⁾	4...20 mA	Connector M12
.../100-H-K35-N	0.1...10 V	
.../160-C-K35-N ¹⁾	4...20 mA	Connector M12
.../160-H-K35-N	0.1...10 V	
.../250-C-K35-N ¹⁾	4...20 mA	Connector M12
.../250-H-K35-N	0.1...10 V	
.../315-C-K35-N ¹⁾	4...20 mA	Connector M12
.../315-H-K35-N	0.1...10 V	
.../315-F-C13-0,50-N	0.5...5 V	Cable 500 mm M12 straight
.../400-C-K35-N ¹⁾	4...20 mA	Connector M12
.../400-H-K35-N	0.1...10 V	
.../630-C-K35-N ¹⁾	4...20 mA	Connector M12
.../630-H-K35-N	0.1...10 V	

Code -N after type designation: Sensor variant with non-removable throttle in the process port on the pressure side.

¹⁾ DNV-GL approval, for availability, see RE 30272

Table 3: Measuring range

Measuring range		Overload pressure		Burst pressure	
bar	PSI	bar	PSI	bar	PSI
0...10	0...145	20	290	200	2900
0...50	0...725	100	1450	200	2900
0...100	0...1450	200	2900	400	5802
0...160	0...2320	320	4641	640	9282
0...250	0...3626	500	7252	1000	14504
0...315	0...4569	630	9137	1260	18275
0...400	0...5802	800	11603	1600	17405
0...630	0...9137	1000	14504	2520	36550

MPa = bar ÷ 10; kPa = bar × 100



The throttle element in the pressure channel of the process port corresponds to an orifice of 0.3 mm. It reduces the risk of damage from highly dynamic effects such as pressure peaks or cavitation.

5 Transport and storage

- ▶ Do not store the pressure transducer outdoors but in a well-ventilated room and, whenever possible, in its original packaging.
- ▶ The storage rooms must be dry and free from corrosive materials and gasses.
- ▶ For transportation and storage of the product observe the permissible ambient conditions.

6 Installation

- ▶ Tighten the transducer. Tightening torques:
For measuring ranges < 400 bar: 20 ... 25 Nm
For measuring ranges \geq 400 bar: 25 ... 30 Nm

7 Electrical connection

1. Disconnect the system from the power supply.
2. Connect the transducer as follows:

Tightening torques of mating connector M12: If no tightening torque is specified, use a value of 0.6 Nm to max. 1.5 Nm.

HM20-2x...C-K35-N (4...20 mA)

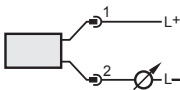

HM20-2x...H-K35-N (0.1 ... 10 V)

HM20-2x/315-F-C13-0,5-N (0.5 ... 5 V)

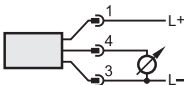

8 Dimensional drawing

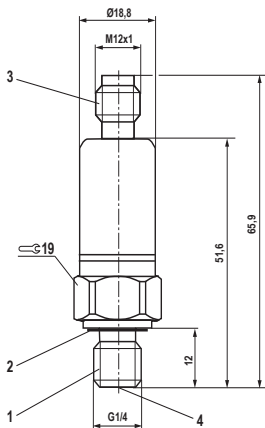

Dimensions in mm

1: Pressure port G1/4 male thread

2: Seal ring NBR

3: M12 connector

4: Throttle element (corresponds to 0.3 mm orifice)

Fig. 1: Pressure transducer HM20-2x/...K35-N

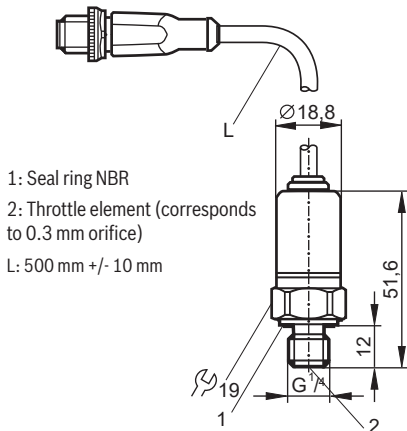

Fig. 2: Pressure transducer with cable HM20-2x/315-F-C13-0,5-N

9 Commissioning and operation

After having been installed, the pressure transducer is directly ready for use.

10 Maintenance and repair

NOTICE

Solvents and aggressive cleaning agents!

Aggressive cleaning agents can damage the seals of the pressure transducer and make them age faster.

- ▶ Never use solvents or aggressive cleaning agents.

Rexroth pressure transducers require no maintenance. Seals are subject to a natural process of wear and aging. It is therefore recommended that they are changed at reasonable intervals. The time intervals are mainly determined by the operating conditions and cleanliness of the hydraulic fluid.

HM20 pressure transducers can only be replaced as a complete unit.

11 Demounting and replacement

1. Disconnect your system from the power supply and depressurize it.
2. Unload hydraulic accumulators, if provided.
3. Make sure that the surroundings are clean for demounting.
4. Collect escaping hydraulic fluid in the provided container and dispose of it properly.
5. Loosen the pressure switch exclusively by means of a suitable tool.

12 Disposal and environmental protection

Careless disposal of the hydraulic components and the hydraulic fluid can lead to pollution of the environment.

- ▶ Dispose of the product, the hydraulic fluid and the packaging in accordance with the applicable national regulations in your country.

13 Technical data

HM20-2x...C-K35-N

Operating voltage [V]	18...36 DC ¹⁾
-----------------------	--------------------------

Analog output	4...20 mA
---------------	-----------

Load [Ω]	max. $(U_s - 8.5 \text{ V}) / 0.0215 \text{ A}$; 720 Ω at $U_s = 24 \text{ V}$
-------------------	---

HM20-2x...H-K35-N

Operating voltage [V]	18...36 DC ¹⁾
-----------------------	--------------------------

Current consumption [mA]	≤ 12
--------------------------	-----------

Analog output	0.1...10 V
---------------	------------

Load [Ω]	min. 2000
-------------------	-----------

HM20-2X/315-F-C13-0,5-N

Operating voltage [V]	16...36 DC
-----------------------	------------

Current consumption [mA]	≤ 12
--------------------------	-----------

Analog output	0.5...5 V
---------------	-----------

Load [Ω]	min. 1000
-------------------	-----------

Material

Housing material	V4A (1.4404), PEI, HNBR
Process port with measuring cell	1.4542 (17-4 PH/630)
Seal ring	NBR
Throttle	1.4305

Cables made of PUR, halogen-free

Min. bending radius, firmly laid	20 mm
Min. bending radius, loosely laid	44 mm

Permissible temperature values	Plug unit	Cable unit
Ambient temperature [°C]	-40...+85	-25...+80
Nominal temperature [°C]	-20...+80	-20...+80
Medium temperature [°C]	-40...+90	-25...+80
Storage temperature [°C]	-40...+100	-25...+80

Protection classes	Plug unit	Cable unit
Protection rating to DIN EN 60529	IP65, IP67	IP65
Protection class	III	
Insulation resistance [MΩ]	> 100 (500 V DC)	

¹⁾ For cULus: max. 30 VDC permitted

Requirements with regard to vibration load and EMC are met, see data sheet.

14 List of addresses

Contact for service and spare parts

Bosch Rexroth AG
Service Industriehydraulik
Bürgermeister-Dr.-Nebel-Strasse 8
97816 Lohr am Main
Deutschland

Telephone +49 (0) 9352/40 50 60
E-mail service@boschrexroth.de

Outside Germany you will find service subsidiaries in your vicinity on the Internet at www.boschrexroth.com

Headquarters

Bosch Rexroth AG
Zum Eisengiesser 1
97816 Lohr am Main
Deutschland

Telephone +49 (0) 9352/18-0
E-mail my.support@boschrexroth.com

The addresses of our sales and service network and sales organizations can be found at www.boschrexroth.com/addresses

Subject to revision
Printed in Germany
RE 30272-B

